

REIPRO

touch the invisible



User Manual

Firmware Version: 1.10.2

Manual Version: 1.4.3

Date of Issue: 23/03/2023

Contents

1	Basic operations	6
1.1	Machine Description.....	6
1.1.1	Front	6
1.1.2	Main connector panel	7
1.1.3	Side connector panel	7
1.1.4	Line management area	8
1.2	Basic functions.....	8
1.2.1	Switching on	8
1.2.2	Switching off.....	8
1.2.3	Recharging the batteries	8
1.2.4	Lock keys.....	8
1.2.5	Reset keys	9
1.3	User Interface	10
1.3.1	Using the Touch Screen	10
1.3.2	General interface philosophy	10
1.3.3	Menu screen	11
1.3.4	Navigating.....	12
1.3.5	Virtual keyboard	13
1.3.6	External inputs and outputs	13
2	Configurations	14
2.1	Synchronization	14
2.1.1	Set synchronization	14
2.1.2	Modify synchro	14
2.1.3	Test synchro.....	14
2.1.4	GPS & Time zone	14
2.1.5	Synchro output	15
2.2	Test Hardware	16
2.2.1	Status Line	16
2.2.2	Test radio signal.....	16
2.3	Basic settings	16
2.3.1	Language.....	16
2.3.2	Import/Export.....	16
2.3.3	Brightness	16

2.3.4	LinkGate Channel.....	16
2.3.5	IP address (Ethernet and WiFi).....	16
2.3.6	Battery calibration.....	16
2.3.7	Timing base calibration.....	17
2.3.8	System status.....	17
2.3.9	System test.....	17
2.3.10	About.....	17
2.4	Common settings.....	18
2.4.1	Time accuracy.....	18
2.4.2	Computer communication.....	18
2.4.3	Displayboard.....	18
2.4.4	Lines.....	18
2.4.5	ReiNet.....	18
2.4.6	Signal light.....	20
2.4.7	Speed Bases.....	20
2.4.8	Modem.....	20
2.5	Line management area.....	20
3	Timing programs.....	21
3.1	Managing a race.....	21
3.1.1	New race.....	21
3.1.2	Recall Races.....	22
3.1.3	Race Export and Import.....	22
3.2	Main Menu.....	22
3.2.1	Timing.....	22
3.2.2	Rankings.....	22
3.2.3	Athletes.....	23
3.2.4	Groups.....	23
3.2.5	Printouts.....	23
3.2.6	Starting lists.....	23
3.2.7	Disqualified.....	23
3.2.8	Computer Communication.....	23
3.2.9	Calculator.....	23
3.2.10	Configuration.....	23
3.3	Single Starts.....	24
3.3.1	Timing screen.....	24
3.3.2	Selecting the desired area.....	24

3.3.3	Entering the bib number	24
3.3.4	What you can do and the operational philosophy	25
3.3.5	Edit.....	28
3.3.6	Fast Edit	29
3.3.7	Next to List.....	29
3.4	Group Starts.....	30
3.4.1	Defining Groups.....	30
3.4.2	Group Rankings.....	31
3.5	Show Jumping.....	32
3.5.1	Timing Screen	32
3.5.2	Sequence of operations during a trial	33
3.5.3	Edit.....	35
3.5.4	Memo	35
3.5.5	Settings	35
3.5.6	Simplified trial configuration	35
3.5.7	Locked Events	36
3.5.8	Route types.....	36
3.6	PC-Online.....	37
3.6.1	Timing Screen	37
3.6.2	Settings	37
3.6.3	Vintage cars	38
3.6.4	Starts.....	39
3.7	Simple Stopwatch	40
3.8	Swimming.....	42
3.8.1	Choosing the configuration	42
3.8.2	Session settings	42
3.8.3	Race settings.....	42
3.8.4	Timing screen.....	43
3.8.5	Race flow	44
3.8.6	Dual touchpads and starting blocks for false starts	45
3.8.7	Settings	46
3.8.8	Screen shortcuts	46
3.8.9	Rowing	46
3.8.10	Rowing with no numbers.....	47
3.9	Parallel.....	48
3.9.1	Timing screen.....	48

3.9.2	Race flow	48
3.9.3	Edit.....	49
3.9.4	Settings	50
3.10	Pursuit.....	51
3.10.1	Timing screen.....	51
3.10.2	Race flow	51
3.10.3	Race Control	54
3.10.4	Logical channel assignment.....	54
3.10.5	Quadruple Pursuit	54
4	Further Details.....	56
4.1	Lines Configuration.....	56
4.1.1	Physical and Logical Channels	56
4.1.2	Lines holdoff times	57
4.1.3	Lines exclusion configuration	57
4.2	Managing Groups	58
4.3	“Philosophical” differences between Parallel and Pursuit.....	59
5	Annexes	61
5.1	Technical.....	61
5.2	Connectors (pin out).....	62
5.2.1	Radio 1	62
5.2.2	Radio 2.....	63
5.2.3	Power Supply	63
5.2.4	Digital I/O.....	63
5.2.5	Analogue I/O.....	63
5.2.6	Computer A.....	64
5.2.7	Computer B / REI2-NET.....	64
5.2.8	Display Board.....	64
5.2.9	Linkpod	65
5.2.10	Timing Inputs.....	65
5.3	Swimming Linkpod configurations	66
5.3.1	Climbing.....	68
5.3.2	Rowing.....	69
5.4	Protocols.....	72
5.5	Rei Pro Updater	72

1 BASIC OPERATIONS

1.1 MACHINE DESCRIPTION

1.1.1 Front

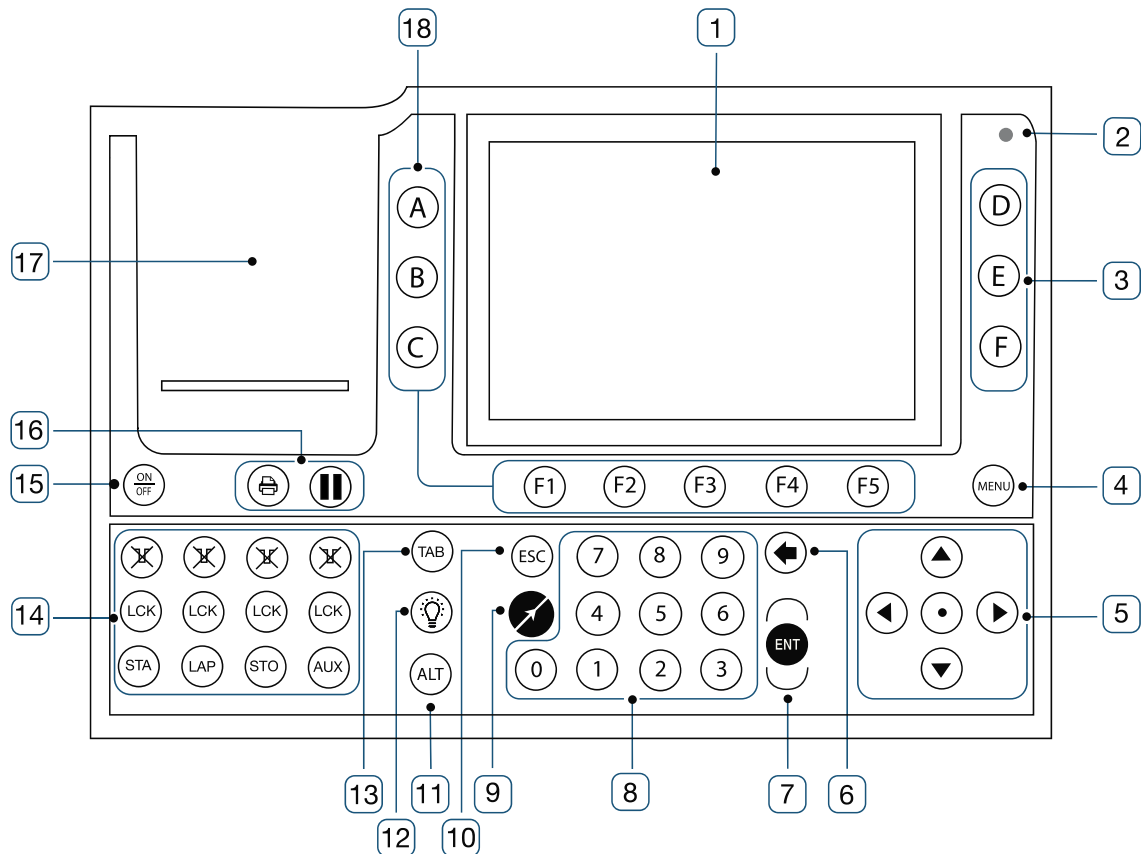

- | | |
|--------------------------|-----------------------------------|
| 1. Colour touch screen; | 10. Escape key; |
| 2. Ambient light sensor; | 11. Alternative function key; |
| 3. Function keys; | 12. Lamp key; |
| 4. Menu key; | 13. Display board management key; |
| 5. Directional pad; | 14. Line management area; |
| 6. Delete key; | 15. On/Off key; |
| 7. Enter key; | 16. Printer management keys; |
| 8. Numerical keypad; | 17. Printer area; |
| 9. Microgate key (MIC); | 18. Function keys. |

1.1.2 Main connector panel

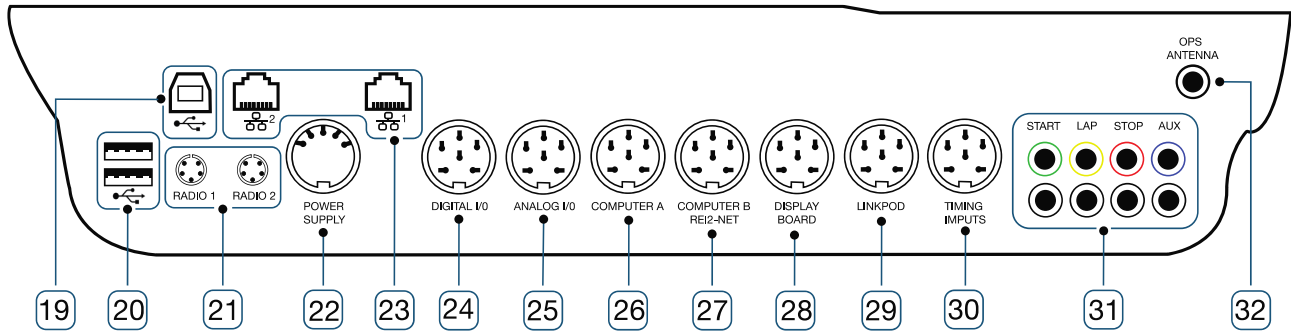

- | | |
|--------------------------------------|---------------------------------------|
| 19. Type B USB port; | 26. Serial communication port; |
| 20. 2 Type A USB ports; | 27. Serial communication port; |
| 21. EncRadio connectors; | 28. Display board communication port; |
| 22. External power supply connector; | 29. LinkPod port; |
| 23. 2 RJ45 ports; | 30. Timing input signal port; |
| 24. Digital communication port; | 31. Input Lines; |
| 25. Analogue communication port; | 32. External GPS aerial connector. |

1.1.3 Side connector panel

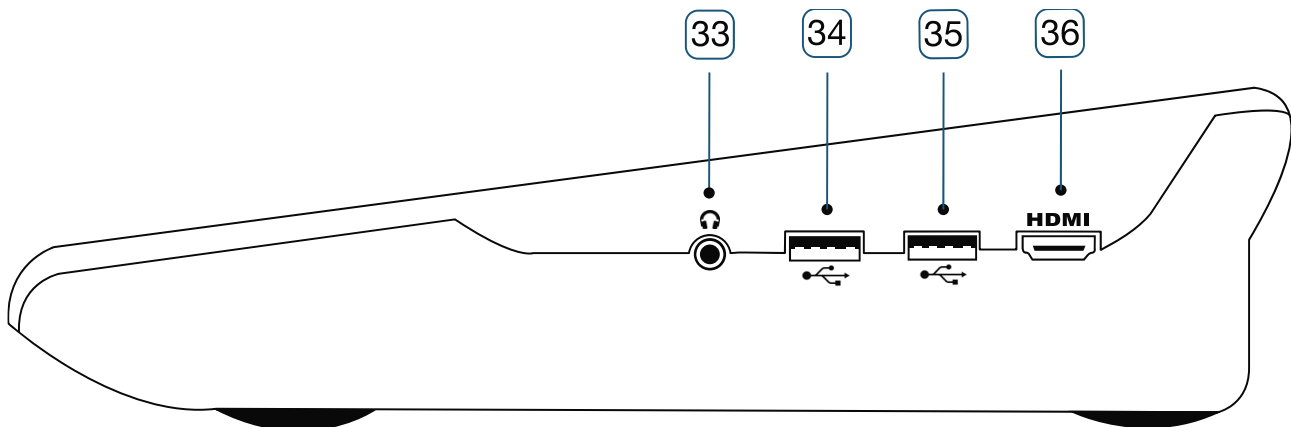

- | | |
|-------------------------------|----------------------|
| 33. External audio connector; | 35. Type A USB port; |
| 34. Type A USB port; | 36. HDMI connector. |

1.1.4 Line management area

- 37. Line Reset status LED;
- 38. Line Reset keys;
- 39. LCK status LED;
- 40. Line lock keys;
- 41. Impulse keys.

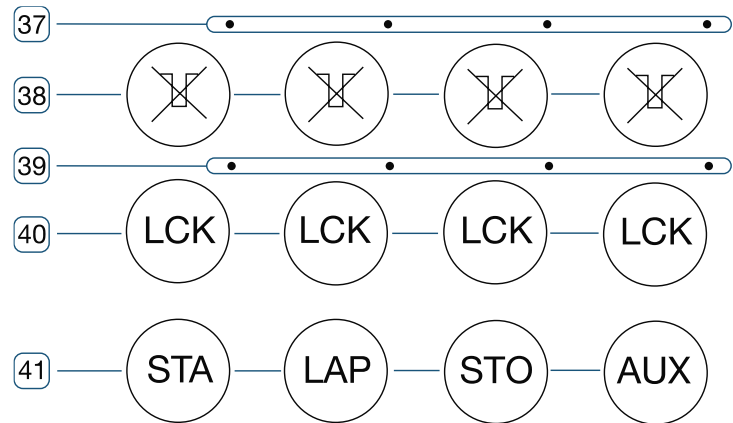

1.2 BASIC FUNCTIONS

1.2.1 Switching on

To switch on the Rei Pro, hold down the on/off key for approximately three seconds.

When switching it on to update the software, press the F1 key together with the on/off key.

1.2.2 Switching off

Hold down the on/off key for approximately three seconds and then press the F1 - "Off" key. Pressing and holding the on/off button for about 6 seconds will automatically switch off, and after 19 the hardware reset will take place.

1.2.3 Recharging the batteries

Connect the power supply provided to the Power Supply connector.

Special software built into the Rei Pro autonomously handles charging the lithium ion batteries, so the timer will remain on for the recharging duration.

If the Rei Pro is off when the external power supply is connected, it will turn on automatically.

There is a battery icon with the percentage  charge to show the progress of the recharging process.

Beware, the Rei Pro does not recharge the batteries when it is off, so it must remain on until the batteries are fully recharged

1.2.4 Lock keys

The Lock keys block reception of events on all the inputs (line, LinkPod, radio) assigned to the blocked logic channel. However, they do not have any effect on the line keys. All the impulses detected on the locked line are saved as usual and can be managed at a later time.

1.2.5 Reset keys

The Reset keys cancel the time delay set for the respective lines. This means you can set the REI so that it can receive pulses without having to wait for expiry of the preset time delay. The zero setting of the time delay, signalled by the flashing of the LED above the key, remains activated until the Reset key is pressed again.

1.3 USER INTERFACE

1.3.1 Using the Touch Screen

The Rei Pro has a capacitive touch screen.

Use your fingers.

Do not use pointed objects such as pens or pencils; they would not work as they are not conductive, and could damage the glass screen.

1.3.2 General interface philosophy

The Rei Pro interface is divided into two main areas:

1.3.2.1 *Start, settings and race management: speed*

The Rei Pro supports tactile interaction only.

Therefore you must use the touch screen to choose the race type and make and settings you need.

Scroll through the various pages using the screen keys or by swiping horizontally.

You can also swipe on a line to cancel the corresponding event.

1.3.2.2 *Timing: accuracy*

Once you have entered the timing screen, you can use either the physical keyboard or the screen to access the functions of the Rei Pro.

Use the function keys to access the functions listed on the screen, or directly touch the function you want to use.

As the timing screen is divided into different areas, the currently selected active area will be identified with a yellow background.

You can disable the touch screen at any time from the menu. **Use the Alt+Mic shortcut to enable or disable the touch screen.**

1.3.2.3 *Using a mix of Touch/Physical keys: greater interaction*



A third method is to mix the touch screen and the physical keyboard. In fact, in the timing screen and many other menus, for example edit, you just need to touch a field to edit it. This gives you the benefit of greater interaction with the timer without making the interface excessively complex, so that it is more user-friendly during frenetic moments of the race.

1.3.3 Menu screen

After switching on the Rei Pro, you can make some basic settings that are common to all timing programs before opening or creating a race.

The colour screen means that you can associate each individual setting type with a single colour, as well as a specific icon.

These three icons will always be there, regardless of the type of race you want to manage:

- Settings 
- Test Hardware 
- Synchronization 

You can also use the following to find your way around the menu:

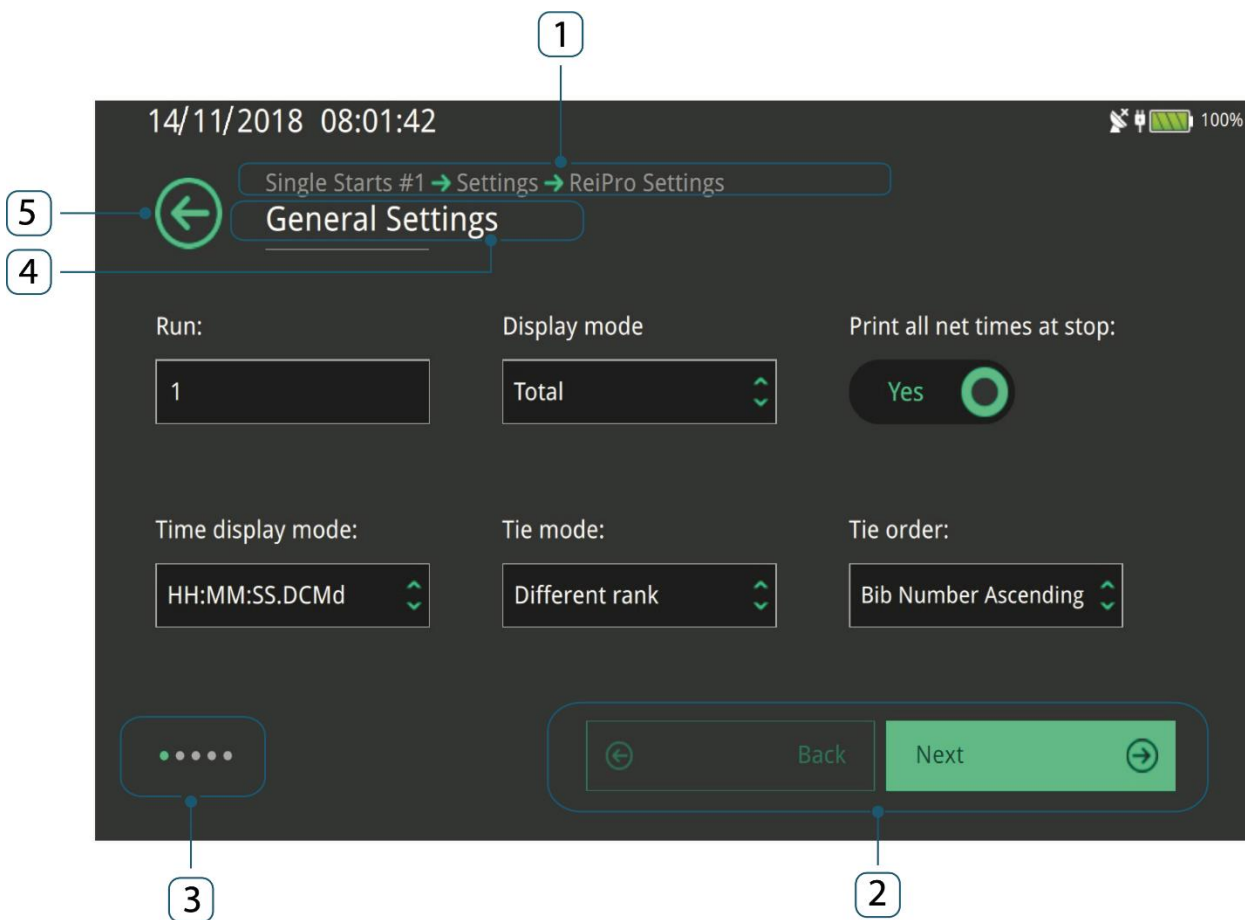

1. Breadcrumb: to see your position in the various menus;
2. Page scrolling: alternatively, you can use swiping;
3. Menu-indicators: to know how many pages make up the menu;
4. Title;
5. Back key: to go back one level on the breadcrumb, you can also use the ESC key.

1.3.4 Navigating

1.3.4.1 Menu Key

This opens the menu when you are in the timing environment, otherwise it performs the “back” function in the menu path.

1.3.4.2 Esc Key

This cancels an entry.

1.3.4.3 MICROGATE Key

Once you have chosen a program, just press this key to  return quickly to the timing window from any page of any menu.

1.3.4.4 Lamp Key

This directly opens the brightness settings.

1.3.4.5 TAB Key

This locks the display board to a single competitor, so you can work on others without displaying them.

1.3.4.6 Pause Key

This pauses the printer. The icon will appear in the bar at the top of the screen.



1.3.4.7 ALT+MIC combination

Direct link to the touchscreen configuration page, the virtual keyboard and the language.

Various shortcuts are available when you are in the timing program:

1.3.4.8 Long press of the LCK key

This directly opens the line lock configuration menu.

1.3.4.9 Long press of the Holdoff key

This directly opens the line holdoff time menu.

1.3.4.10 ALT+TAB combination

If you want to work on correcting the times without showing them on the display boards connected to the Rei Pro, you can use this key combination to clear and block all the display boards, and then restore them later.

1.3.4.11 ALT+E combination

In programs with Fast Edit, this lets you quickly change the Fast edit/Starting list/Next to list visualization.

1.3.4.12 ALT+LCK combination

Displays the menu for management of locked events.

1.3.5 Virtual keyboard

You can use the virtual keyboard whenever you need to enter data, such as the name of a race, a competitor or a group. It will be displayed automatically as soon as you touch an area that requires it.

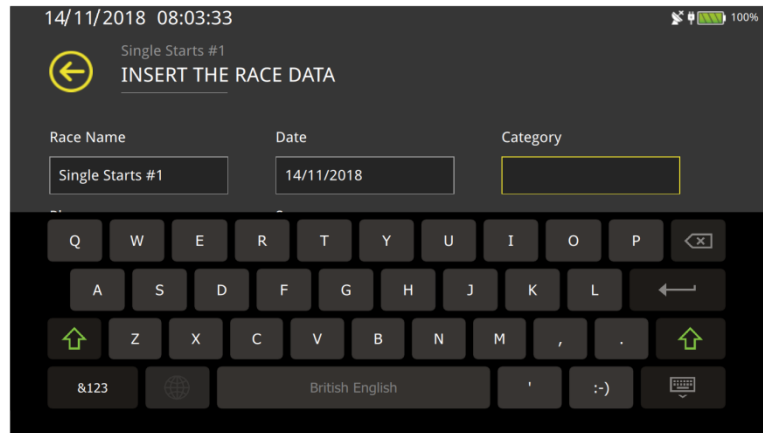

1.3.6 External inputs and outputs

The Rei Pro makes it easy to use various external peripherals.

Use one of the USB ports to connect a keyboard, mouse or both, either wired or wireless. Improve the ergonomics of the timing station. If you want to use a physical USB keyboard, disable the virtual keyboard from the menu or using the ALT+MIC shortcut.

You can also connect a high-definition screen or projector to the HDMI port. Use this option either for teaching purposes or in a racing environment. Caution: if your external screen does not support the screen resolution of the Rei Pro (800x480), try switching the timer and then on again while holding down F5 to enable the HDMI video output alone.

2 CONFIGURATIONS

In both the home screen and the menu of each program, there are three icons at the top right to let you quickly access all the Rei Pro settings.

You can edit some of them in the home screen as soon as you switch on the timer, while the program-specific ones are only available later, in the race menu.

2.1 SYNCHRONIZATION

The synchronization menu is available in all programs and consists of the following sub-menus:

2.1.1 Set synchronization

“Traditional” synchronization. Set a time and date, and synchronize the Rei Pro with an impulse on the Start line (line, radio or button).

2.1.2 Modify synchro

You can change the time and date of the timer by a positive or negative offset.



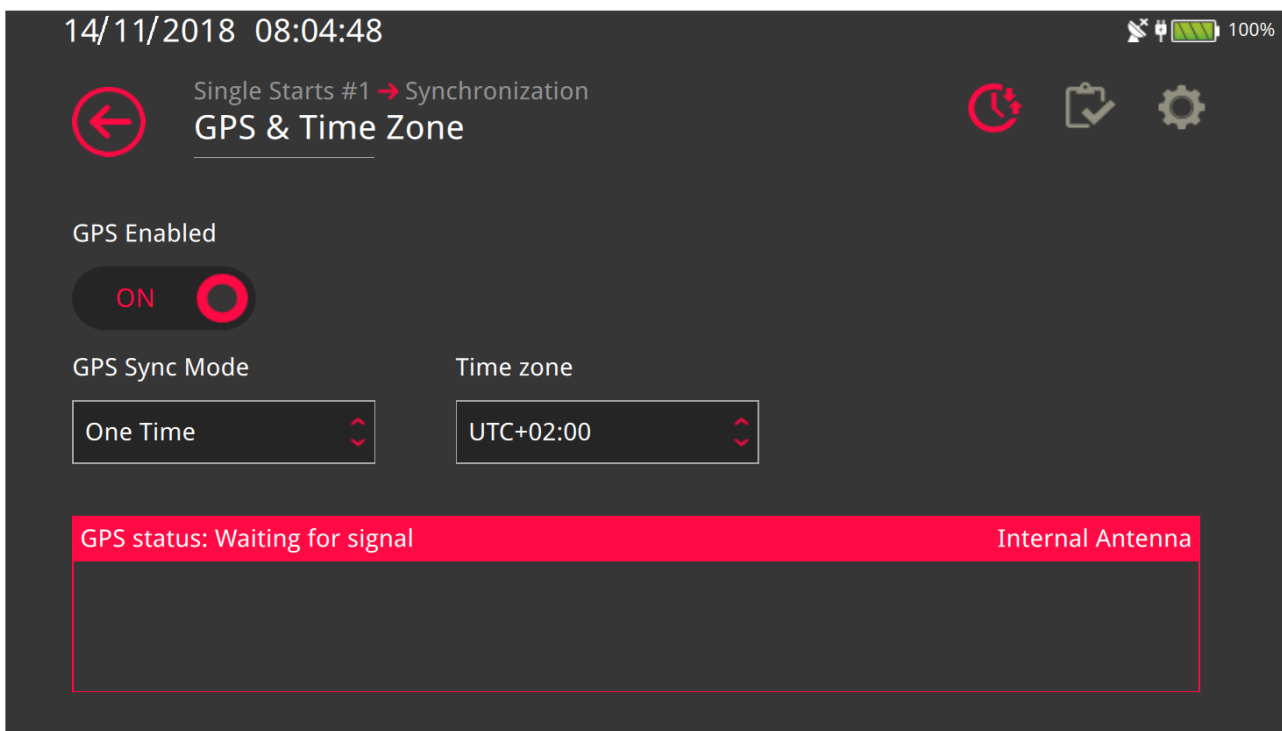

2.1.3 Test synchro

Connect an external synchronizer and check the difference between the synchronizer and the timer.

2.1.4 GPS & Time zone



The Rei Pro has a built-in GPS receiver. There is an icon next to the battery icon to show the satellite signal reception status:

- No icon if GPS is disabled;
- White icon with an X if GPS is enabled but not linked to any satellites; 
- White icon with a signal if GPS is enabled and linked, but synchronization has not been enabled; 
- Green icon if GPS is enabled and linked, and the Rei Pro is synchronized; 
- Red icon if GPS is enabled but not linked, and the Rei Pro has lost synchronization. 

You can decide whether to enable it or align with the official time.

There are two possible GPS synchronization methods:

2.1.4.1 One-time GPS synchronization

Once the Rei Pro has acquired the correct satellite signal, it synchronizes the time with the official time and then relies on its internal quartz oscillator.

2.1.4.2 Continuous GPS synchronization

After aligning solar time with that of the GPS signal, the Rei Pro will continue to keep itself aligned. This requires a continuous link with the satellite signal. The Rei Pro will remain synchronized with the GPS as long as it receives the signal correctly. If the signal is lost, the timer will use its internal quartz oscillator. If the GPS signal then returns, the Rei Pro will use it to realign the internal time if the difference is less than 300 μ s.

When working in an enclosed space, use an external aerial connected to the dedicated port to receive the GPS signal correctly.

You must set the time difference between your location and UTC:

2.1.4.3 Setting the UTC value

Coordinated Universal Time (UTC) is the reference time from which all other time zones are calculated.

UTC+0 refers to the time zone at the Greenwich meridian and, since daylight saving time is an invention (which is not even used throughout the world), the UTC value does not consider it.

When solar time applies in Europe, the value will be UTC+1, and when daylight saving time applies, you should set UTC+2.

The UTC is only used when the timer is synchronized via GPS.

2.1.5 Synchro output

You can set a time (HH:MM:SS) at which the Rei Pro will generate an output impulse on the digital port (Pin 6).

You can also set a repeat time.

2.2 TEST HARDWARE

2.2.1 Status Line

This gives a general overview of the status of the physical lines and any LinkPods connected.

2.2.2 Test radio signal

You can check the properties of a received radio impulse, such as its channel, logical channel and signal strength.

2.3 BASIC SETTINGS

These are the settings available from the home screen, before choosing a program:

2.3.1 Language

You can change the language of the Rei Pro interface at any time.

2.3.2 Import/Export

You can import a race configuration saved previously or a race database. You can navigate through the folders on your USB drive, and the Rei Pro will only display the files that you can import.

2.3.3 Brightness

You can manage the screen brightness, auto brightness controlled by the sensor and power saving. You can only set the brightness manually when auto brightness has been disabled.

2.3.4 LinkGate Channel

Set the LinkGate channel for receiving signals sent by EncRadio or Polifemo Radio.

2.3.5 IP address (Ethernet and WiFi)

The Rei Pro has two TCP/IP communication network ports. Use this menu to choose whether to give the timer a fixed IP address or let the router DHCP to which it is connected assign an IP address.

The Rei Pro is also equipped with WiFi. To configure the WiFi, simply set the Adapter type as WiFi and press F1 to enter the setup menu. After enabling WiFi, you can choose which network to connect to by setting the password and pressing the Select Network button.

2.3.6 Battery calibration

The Rei Pro has an advanced lithium ion battery. To ensure that the timer display corresponds to the real battery charge state, you should calibrate the batteries at least one per year. To do so, carry out the following steps:

- Disconnect the power supply from the Rei Pro;
- Run the battery calibration;
- The software will discharge the battery to the minimum possible level;
- Reconnect the external power supply as soon as the Rei Pro turns off;
- When the timer turns back on, it will start to recharge the batteries;
- The calibration will be complete when recharging has finished.

This is not a fully automatic procedure, so we recommend not carrying it out close to an event during which you will need to use the timer.

2.3.7 Timing base calibration

Once you have enabled GPS and linked to the satellites, you can check the difference between the internal time and that of the satellite signal. If the offset is too great, execute timing base calibration to realign it with the GPS.

2.3.8 System status

This is an overview of the physical properties of the Rei Pro.

2.3.9 System test

If your Rei Pro malfunctions, save the system Log and send it to us so we can identify and correct any issues.

2.3.10 About

This gives information about the Rei Pro serial number and the version of the operating system installed on it.

2.4 COMMON SETTINGS

The settings menu contains some items that you will find in all the timing programs, albeit with a few differences related to the different race types:

2.4.1 Time accuracy

You can choose the accuracy of the times displayed during a race.

- Time accuracy: change the accuracy of the net times that the Rei Pro generates. Regardless of the value you choose, the time measurements will always be saved with the maximum accuracy that the Rei Pro can handle (1/50000 s), so you can change the accuracy and recalculate the net times, unless you change the last parameter of this list.
- Time rounding: you can decide at which digit to round up to the next significant unit (e.g. millisecond accuracy, value set to 5 and solar time 12:00:09.4613, the fifth seconds digit, i.e. 1, will be rounded up. So the solar time will become: 12:00:09.461);
- IAAF Rule: this is special time rounding that rounds the net value up (e.g. accuracy set to 1/100 s and net time 25.4625 s, will become 25.47 s with the IAAF rule)
- Round off chrono: you can also decide to truncate the time measurements to the same accuracy as the net times. In this case, you will not be able to recalculate the net times to increase their accuracy.

2.4.2 Computer communication

This lets you set the serial port and USB Host (port type A) communication individually, including the protocol. You can decide whether to transmit the data on receiving it for each single event (Online Data), or to transmit it all together at the end of the race (Offline Data), or even to send the running time (Tick).

2.4.3 Displayboard

This menu lets you configure whatever you “connect to each end of the display board cable”. In fact, you can configure the display board output of the timer (setting the speed, pause for Lap, Stop or other events) and which display boards will be connected to the other end of the cable. You can choose the type of display board connected to the Rei Pro and which of the available visualizations to use.

Address	Display	Num.	Visualization	IP Address
0	uGraphLED	2	Athlete Name	192.168.001.101
1	uGraphLED	2	Graphic Time	192.168.001.102
2	uGraphLED	2	1&2 Num Time Name	192.168.001.103
3	uGraphLED	2	3&4 Num Time Name	192.168.001.104

You can also use a network cable to connect to more than one display board; just enter the destination IP address, i.e. that of the display board.

2.4.4 Lines

This sets the physical and logical channels and manages the disable times and contact type. (See Further Details)

2.4.5 ReiNet

Manage the various parameters of the Rei Pro-Rei Pro networks.

Each ReiPro is equipped with two Ethernet ports. To connect two or more timers together, you can daisy-chain them one after the other using the two Ethernet ports or else create a classic star network using an Ethernet switch.

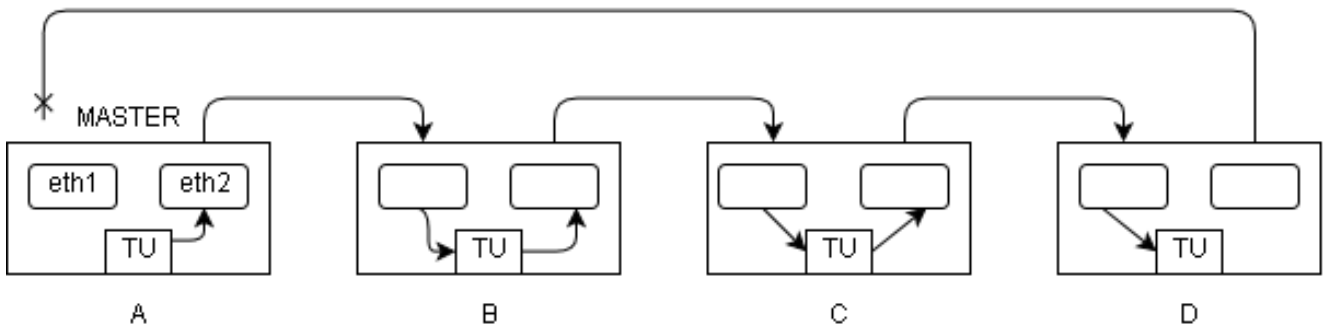

For synchronization, configure one timer as the MASTER that distributes the synchronization to all the other timers connected to its Ethernet ports.

The MASTER can be synchronized via GPS or an external device.

In addition, the MASTER manages the distribution of the IP addresses via DHCP for each device in the network.

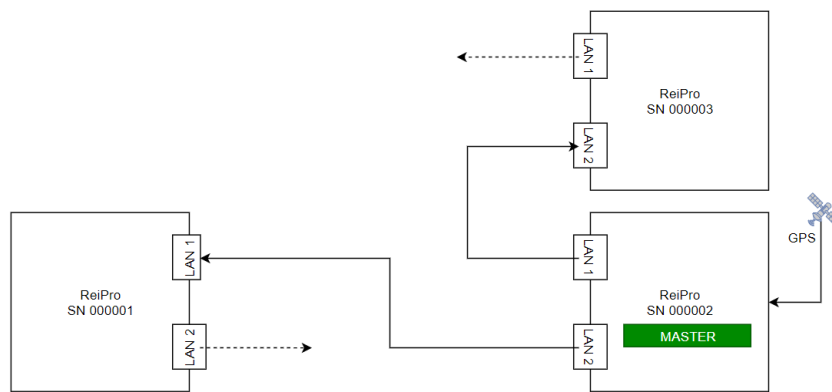

Daisy Chain connection

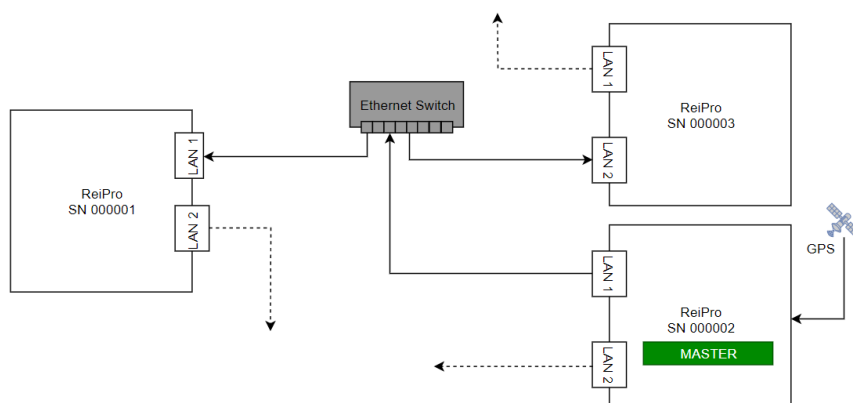

Connection via central Ethernet switch

2.4.6 Signal light

This lets you program the μ Sem signal light or a “virtual” traffic light to manage various types of start cycle.

2.4.7 Speed Bases

You can enter the lengths of various sections of the race course for the speed calculation. You can set both the total course length and individual lap lengths.

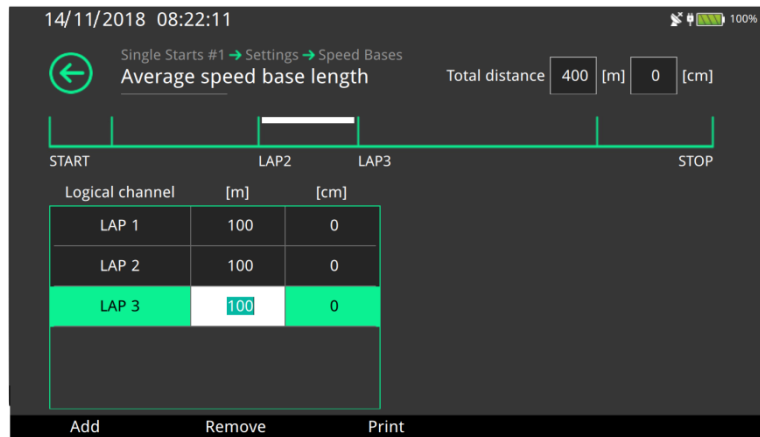

2.4.8 Modem

You can control the use of a GSM modem connected to the timer. With the GSM modem you can connect between two ReiPros directly with the data call or between multiple timers by sending SMS messages.

2.5 LINE MANAGEMENT AREA

There is a specific area on the Rei Pro keyboard dedicated to managing the lines.

You can generate an impulse with specific keys for each line [41], you can disable acquisition with the corresponding key [40] and even reset the line holdoff time with the Holdoff key [38] if you need to. The LEDs on the individual line disable and Holdoff keys flash to indicate that the specific functions is enabled.

The LEDs on the Holdoff keys also have a second function: if the Rei Pro detects a short circuit on a line, the corresponding LED will remain on continuously to warn of the problem.

3 TIMING PROGRAMS

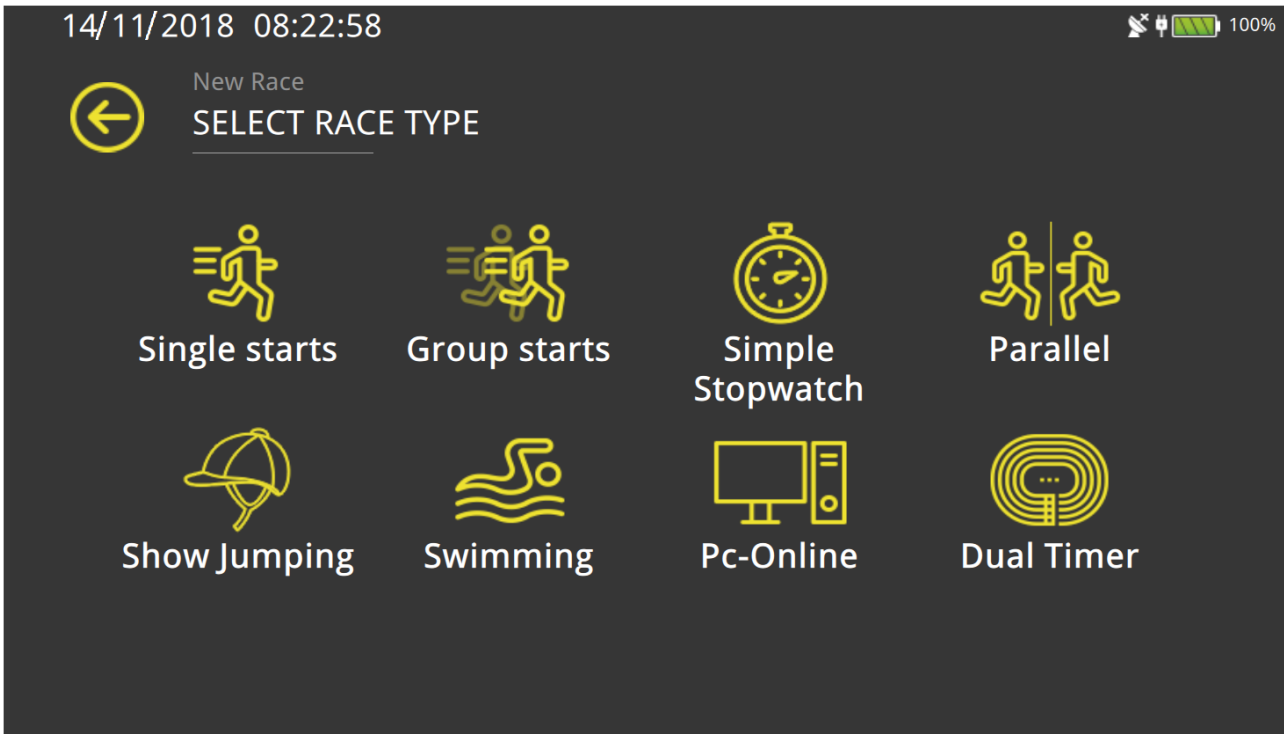

3.1 MANAGING A RACE

The Rei Pro is able to store an almost unlimited number of races. Therefore, you can exit the current race at any time, open and manage a new one (or one that you created earlier), and then return to the original one.

All data will be saved continuously in the timer memory and will remain stored until you decide to delete it.

You can start a specific race in three different ways, depending on your needs:

3.1.1 New race

Touch the “New Race” icon to display the list of available race types, followed by a list of possible configurations for the chosen program.

Once you have done this, the next screen in which you enter the race identification data is common to all programs and configurations. Touch the available fields to enter the race data using the virtual keyboard.

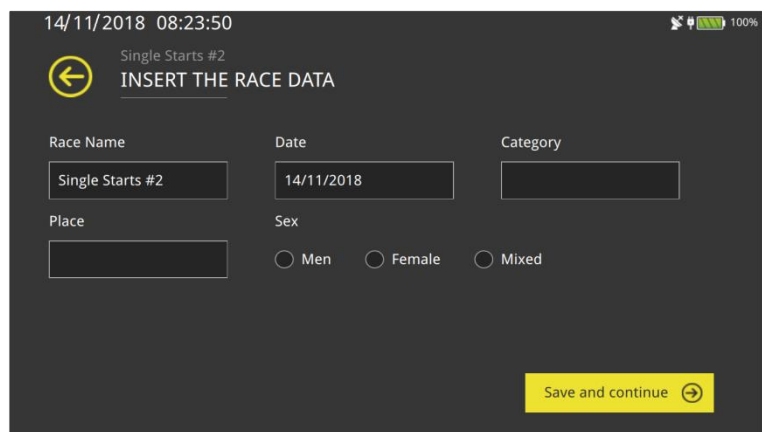

If the new race you are creating is of the same type as the last race, the Rei Pro will ask if you want to keep the same race configurations. So, if you want to manage several races of the same type within a single event, you can create “twin” races so that you do not have to set all the parameters, such as displayboards, line configuration, etc. each time.

3.1.2 Recall Races

If the race was created previously, you can recall it by touching the “Recall Races” icon.

The next screen will let you:

- See the complete list of races in memory;
- Choose one of the races by touch or using the directional pad;
- Use the search fields to find the races you want quickly;
- Recall the highlighted race;
- Delete the highlighted race;
- Duplicate the highlighted race;
- Export the database of the highlighted race;
- Delete all stored races.

All of the choices (except for export) require confirmation for safety.

The races list will be displayed in the order of the dates on which they were defined and inserted.

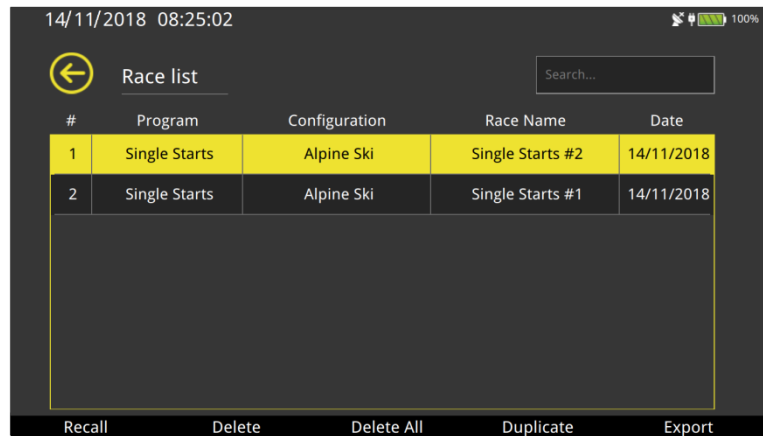

3.1.3 Race Export and Import

Access this way of creating a race from the menu Settings > Import/Export.

The Rei Pro will offer you a list of folders, depending on what you want to do, export or import a race configuration or DB. Specifically, the “Config” folder is inside the timer, while the memories connected to the USB ports will be identified as External USB Memory. You can navigate through them and choose the folder you want to use. When importing a race configuration or DB, the Rei Pro will only display the files of the corresponding type, to avoid showing you the entire folder contents.

3.2 MAIN MENU

Regardless of the race program you decide to use, the main menu lets you manage the race:

3.2.1 Timing

This opens the timing screen (which you can also access at any time with the MIC key)

3.2.2 Rankings

You can generate and print the rankings in order of arrival time, lap time or bib number. You can also filter a specific competitor, include DNS, DNF or not, or print a list of times.

3.2.3 Athletes

This lets you autonomously create a list of athletes with bib number, name, surname and nationality. Obviously, you can also do it during the race or afterwards to obtain a ranking with updated personal details. You can use the AUX field to enter any kind of additional information.

3.2.4 Groups

You can define groups and sub-groups, and assign them to either a range of bib numbers or a single bib number. You can also do so from the timing screen during a race.

3.2.5 Printouts

This prints the solar times or the list of DNS, DNF or disqualified competitors, with the option of numerous filters.

There are also various printer settings, including “reduced printout”, which saves thermal paper at the expense of “compressing” the printed information.

3.2.6 Starting lists

You can define an automatic starting list by setting the bib number range, increment, gap, and the time and date of the first, or you can define one manually by entering the bib numbers individually. Everything will be linked to the personal details, if entered.

3.2.7 Disqualified

You can check the status of a specific competitor of a certain run, in order to disqualify them or put them back in the race, if necessary.

3.2.8 Computer Communication

You can send data to a computer, with a choice of what to send, or you can receive data.

3.2.9 Calculator

A sexagesimal calculator.

3.2.10 Configuration

This lets you change the program configuration and the data used to define the race.

3.3 SINGLE STARTS



3.3.1 Timing screen

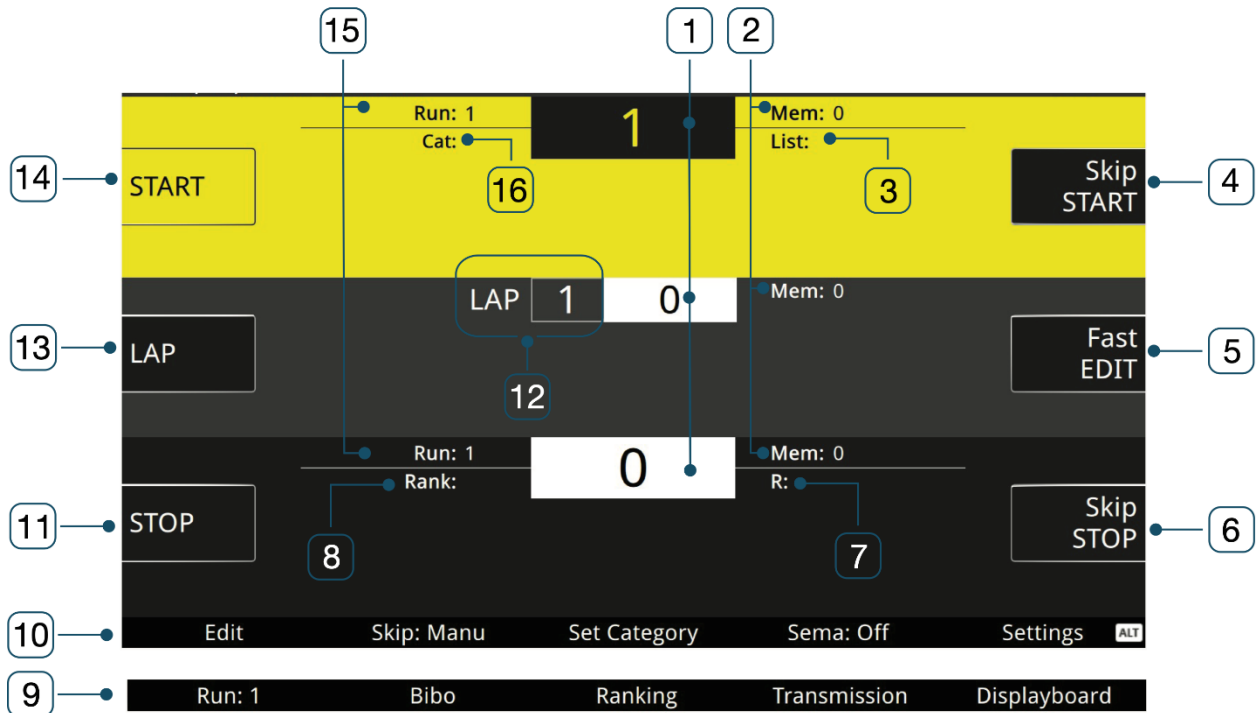

- | | |
|---|--|
| 1- Bib number; | 8- Ranking of the displayed bib number; |
| 2- Count of the events in memory; | 9- Function keys with ALT pressed; |
| 3- List of starting bib numbers; | 10- Function keys always displayed; |
| 4- Start impulse skip quick key displayed, pressing ALT sets the competitor as Did Not Start; | 11- Stop area select key; |
| 5- Fast edit / Next to list; | 12- Lap counter; |
| 6- Stop impulse skip quick key displayed, pressing ALT sets the competitor as Did Not Finish; | 13- Lap area select key; |
| 7- List of running bib numbers; | 14- Start area select key; |
| | 15- Number of runs for the displayed bib number; |
| | 16- Category. |

3.3.2 Selecting the desired area

For the single starts program, the timing interface is divided into three areas: **Start, Lap and Stop**.

You can select one of these three areas either by touching the corresponding box on the left or by pressing the corresponding function key. The selected area will have a yellow background.

3.3.3 Entering the bib number

After selecting the area, just type your chosen bib number on the numerical keypad and press the ENT key.

When an impulse has been acquired for the selected area, a graphical countdown will be displayed in the number box to indicate the time remaining until the entered number is confirmed automatically.

Just type any number to prevent automatic confirmation.

3.3.4 What you can do and the operational philosophy

The Rei Pro lets you do much more than any screen can contain, and an interface that is too full of keys would be impractical to use during a race.

To allow you to work quickly, the functions are displayed in three modes:

- **Race management:** no upcoming event to manage, you are interested in the race in general;
- **Current event management:** the event has just been acquired, you are interested in managing it;
- **Past event management:** no upcoming event to manage, just past events to correct.

3.3.4.1 Race management: bib number confirmed (no.+ENT) or no bib number;

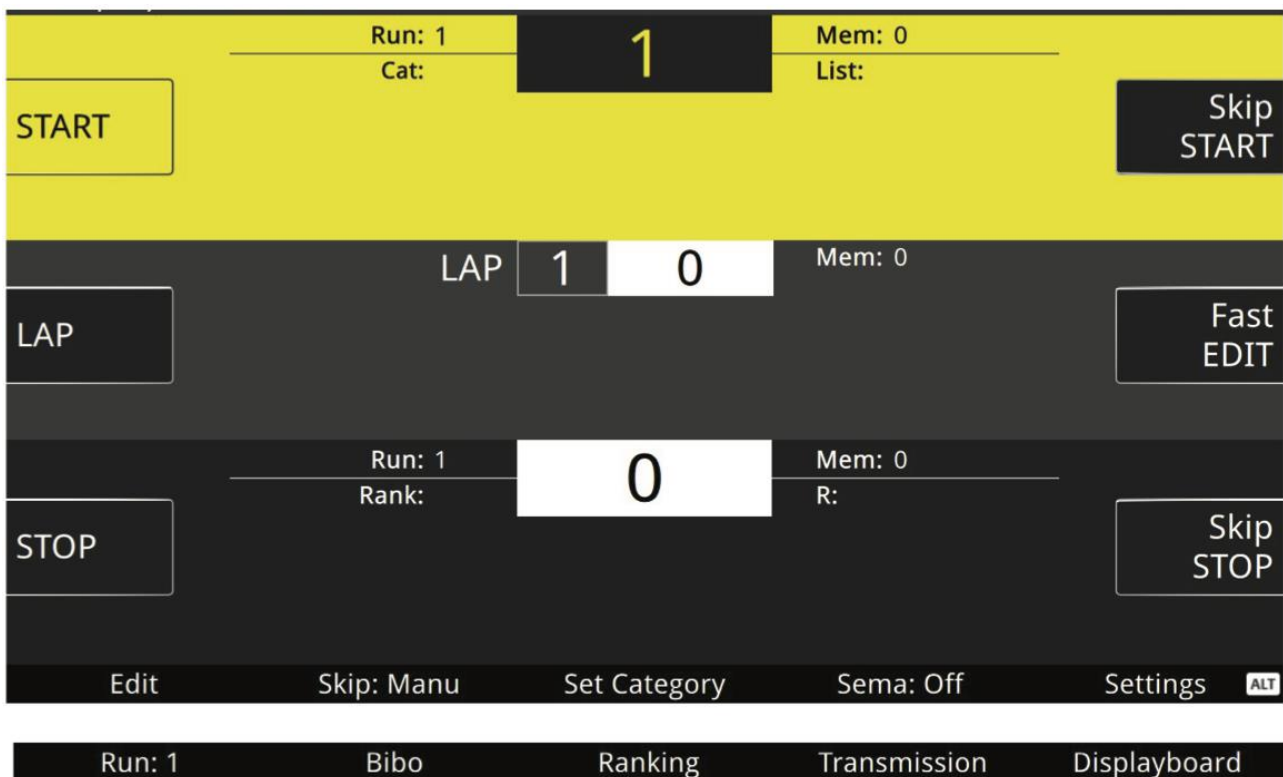

When preparing a race or while waiting because there is no event to manage, you can manage other aspects of the race not strictly linked to an impulse:

- **Edit:** opens the Edit page;
- **Skip Setting:** you can choose to skip only the events you have chosen (Manual Skip), all of those related to the Lap and Stop lines (Auto Skip), only those without previously assigned bib numbers (Semi Auto Skip) or all the impulses (Skip All)
- **Insert Category:** sets the category to which the next competitors belong;
- **Signal light:** you can create and manage a sequence of starts to handle false starts, which can be either physical, visible via μ Sem, or virtual;
- **Settings:** shortcut to the software settings page for the current race;
- **ALT+F1 Change Run;**
- **ALT+F2 Bibo:** Reverse the starting order of the second run;

- **ALT+F3 Ranking:** displays, filters and prints the rankings for the current race;
- **ALT+F4 Transmission:** shortcut to the configuration menu for data transmission to the PC;
- **ALT+F5 Displayboard:** shortcut to the configuration menu for the display boards.

3.3.4.2 Current event management: impulse just acquired and not confirmed nor managed

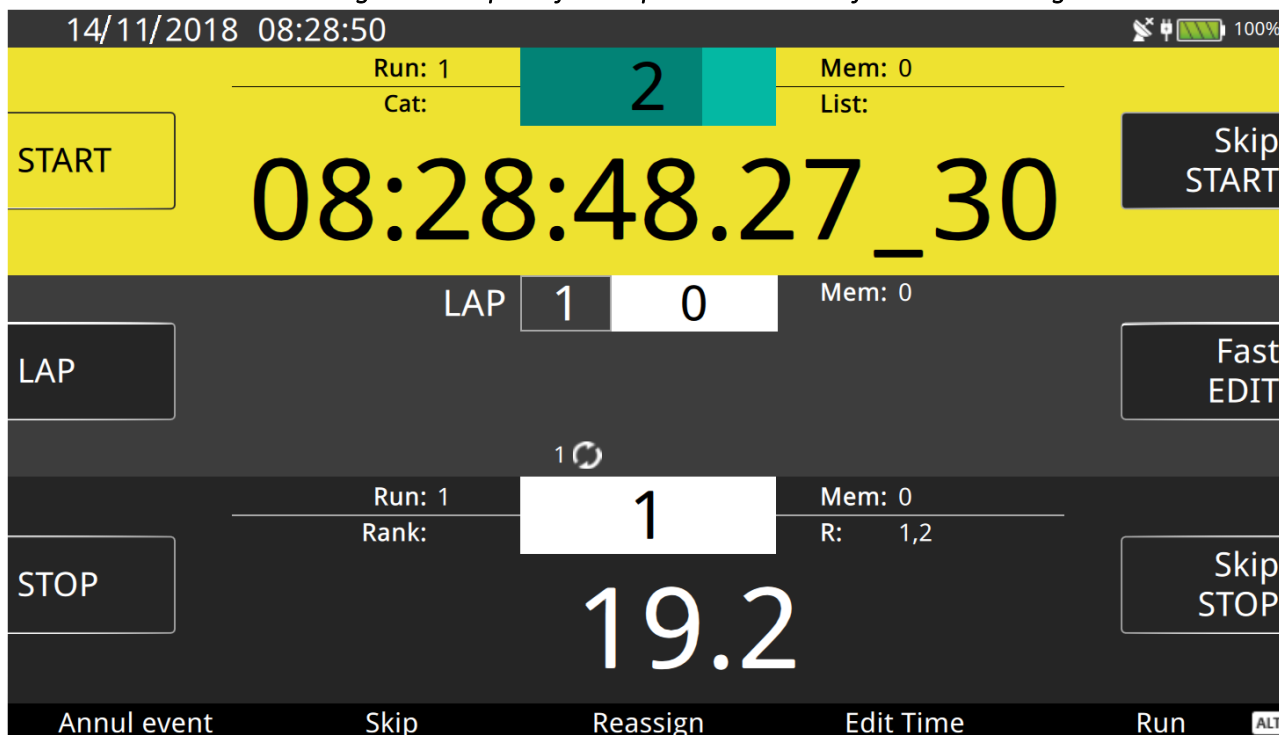

When an impulse or string of impulses arrives, focus will be on managing the first event of the string, which will be displayed large in the corresponding area. The figure shows a Start event.

You can now choose to:

- **Confirm** the event and number by pressing the ENT key;
- **Annul** the event (F1). Obviously, the solar time will not really be lost, but just marked as annulled, but since it is in memory you can retrieve it with the Edit function;
- **Skip** the event (F2). If you are unsure how to manage the event, you can enter it in the list of skipped times and manage it later, or not.
- **Reassign** the event. If you want to use the same solar time for more than one competitor, just press F3 and then type the new competitor.
- **Edit Time.** You can correct the solar time by pressing F4 and typing the new value.
- **Change Run.** You can use the F5 key to assign the competitor's time for a specific run on the fly.
- **Skip All.** If you have acquired several times on the same line, you can press ALT+F2 to skip all of them and manage them later.
- **Insert New.** If you need to assign the same solar time to another bib number, just press ALT+F3 and type the new number to which you want to assign the same time.

Once you have managed the displayed event, you will be offered the following ones, if there are any. Just look at the event counter to see how many are queued.

3.3.4.3 Past event management: bib number typed but not confirmed

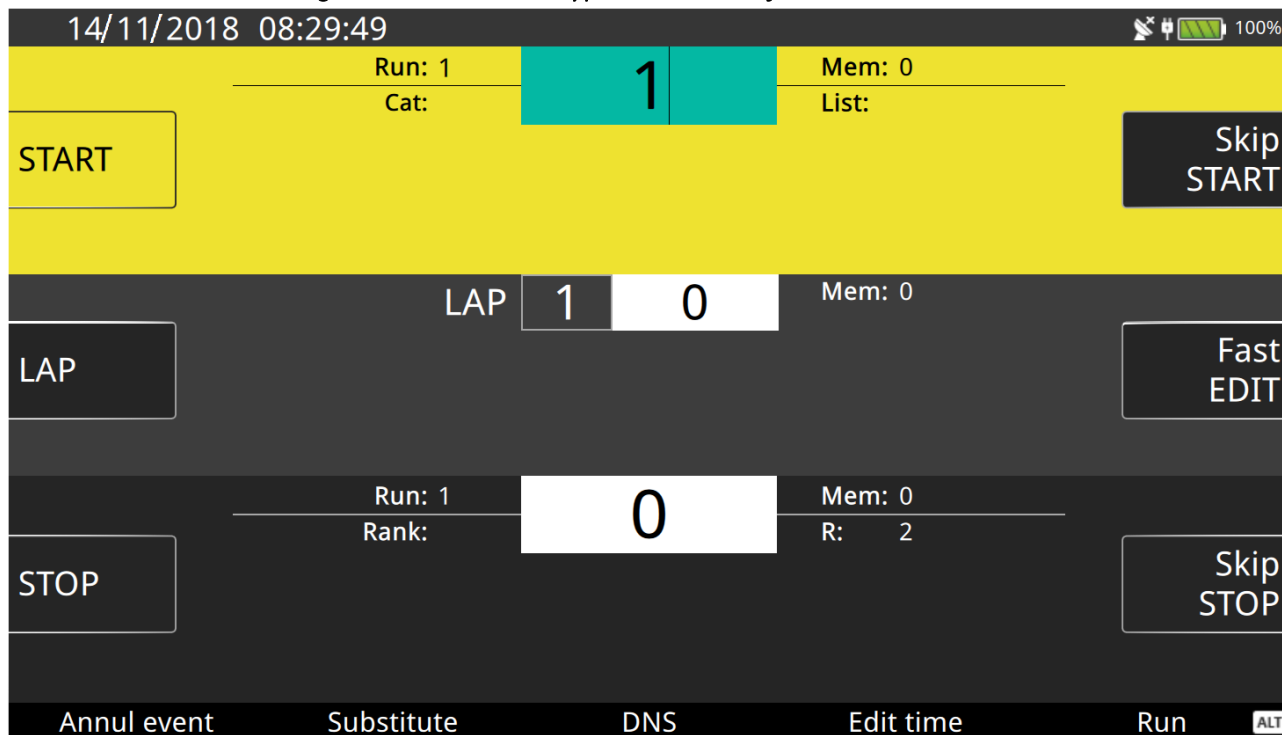

Once all the events in memory have been handled, you can manage events that have already been acquired (and managed).

Select the area you want, type the bib number without pressing ENT, and the Rei Pro will offer the following options:

- **Annul** the event associated with the bib number you typed;
- **Substitute** the number with another. Here, you actually have two options: you can associate a new bib number with the solar time (annulling the previous one, if necessary), or you can swap the relative assignments (e.g. initial situation: no.1 = 08.00.00 and no.2 = 08.00.01, after swapping: no.1 = 08.00.01 and no.2 = 08.00.00).
- **Assign labels** DNS (Did Not Start) or DNF (Did Not Finish);
- **Edit Time**;
- **Change Run**;
- **Add Category**, which you can create on the fly or from the group management menu;
- **Send the event to the PC**.

3.3.5 Edit

You can manage events organically in the edit page as it provides an overall and detailed view of all the impulses received during the race.

The screenshot shows the 'Edit' page in the REI PRO application. At the top, it displays the date and time: '14/11/2018 08:31:29'. Below this is a table with columns: '#', 'Bib', 'Time', 'Logical', 'Physical', and 'Run'. The table contains five rows of event data. The fourth row is highlighted in yellow. To the left of the table are three filter buttons: 'START Filter' (26), 'LAP Filter' (25), and 'STOP Filter' (24). To the right are three control buttons: 'SKIP Filter' (17), 'Show Annulled' (18), and 'New Event' (19). At the bottom of the screen are four input fields: 'Annul' (23), 'Next Bib' (22), 'Search Bib' (21), and 'Search #' (20).

#	Bib	Time	Logical	Physical	Run
3	1	08:30:34.09_20	START	Line Start	1
4	2	08:30:48.49_60	START	Line Start	1
5	3	08:31:06.01_70	START	Line Start	1
6	4	08:31:18.88_60	START	Line Start	1

- 17- Skipped event filter key;
- 18- Annulled event visualization key;
- 19- Add new event key (#);
- 20- Search event ID;
- 21- Search bib number;
- 22- Type the number to assign to the next impulse received;
- 23- Annul the selected event;
- 24- Lap event filter key;
- 25- Stop event filter key;
- 26- Start event filter key.

The table displayed will correspond to the selected filters and will let you edit the properties of each event, such as the bib number, solar time, runs and logical channel. **Obviously, the modified solar time will be given on the printout, marked with *m.**

The events will be in the order of their IDs, so you will find the most recent at the bottom.

If events are acquired while you are in the Edit page, the Rei Pro will automatically highlight the last impulse received, unless you are typing something.

3.3.6 Fast Edit

If, however, you want to maintain full control over the race, but need to edit, or even just see, the event time measurements related to a line, you can use the Fast Edit mode.

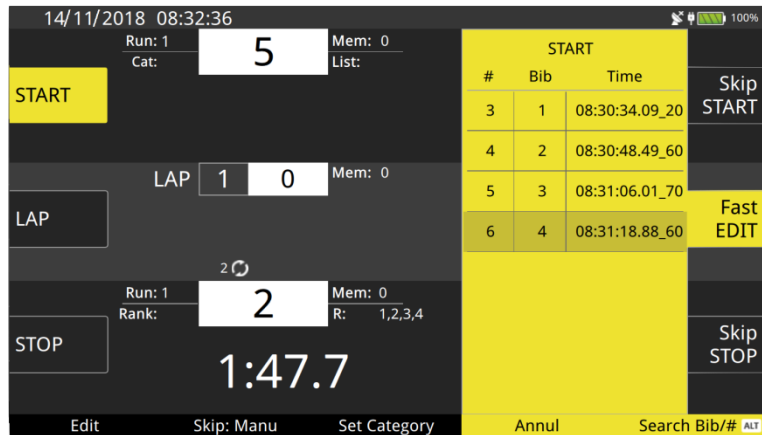

Fast Edit has two different displays: press the Fast Edit key or the corresponding function key (E) once to keep the focus on Fast Edit (which will have a yellow background) and so that you can edit the bib number of the line you touch. Alternatively, press it a second time to move the focus to the race (the yellow background will follow) to have full control over the lines and see the time measurements. Press it a third time to close Fast Edit and return to the race.

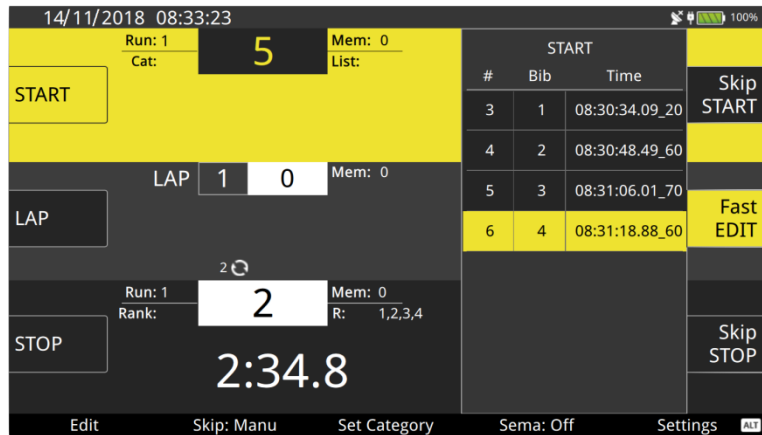

The context of Fast Edit will be the line that you decide to control, so just touch to move from one line to another, and Fast Edit will follow.

3.3.7 Next to List

While Fast Edit lets you see the acquired events, accessing the Next to List function with ALT+Fast Edit (or ALT+E) lets you look to the future by displaying a list of the next competitors in the start list, or the bib numbers that have already started and are about to reach the Lap or Stop line.

You can then type the number of the next competitor on the keyboard or choose one from the Next to List.

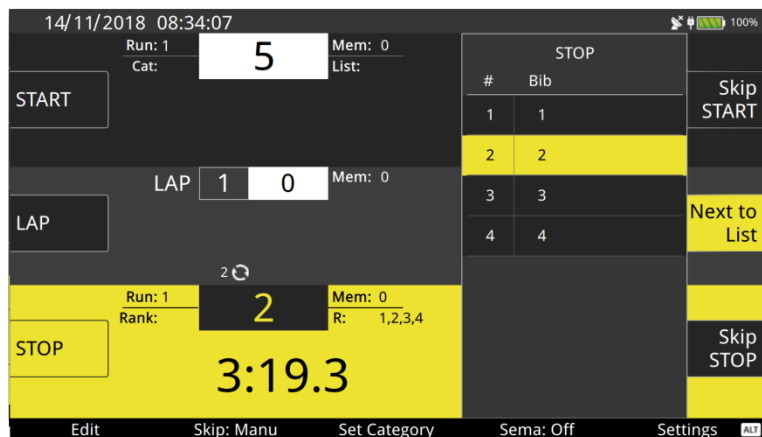

After selecting the list, you can change the next ones to finish with ALT+Arrow Key.

In the case of a selected Lap line, it is possible to display all the laps by moving the list to the left or right.

3.4 GROUP STARTS



The Group Starts program has the same features as the Single Starts program, with some basic differences. In fact, the start impulses will no longer be related to the specified bib number, but to the specified group. The number that you type on the Start line will specify the starting group of competitors. As for single starts, the Lap and Stop impulses will obviously relate to single bib numbers. In other words, the Start applies to the whole group, while the other impulses apply to the individual competitors. It is obvious that editing a Start event will modify the start time of all the competitors in that group, while editing the Lap or Stop times will only affect that specific bib number.

You must define the composition of the groups.

3.4.1 Defining Groups

With the Groups menu open, you can easily create groups and sub-groups. Select New group, give it a name and create as many sub-groups as you want within it, defining them as you like.

The group number (#) corresponds to the bib to be set at the start, while the name is only approximate. You can use the ALT + Arrow keys to move a group up or down (and then change the bib number).

In the example, the following were created:

- Group 1 containing bib numbers from 1 to 10 and odd bib numbers from 11 to 19;
- Group 2 containing bib numbers from 11 to 20;

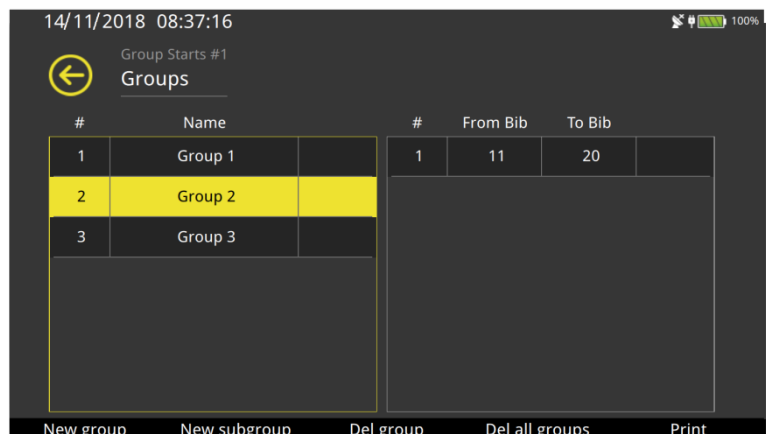
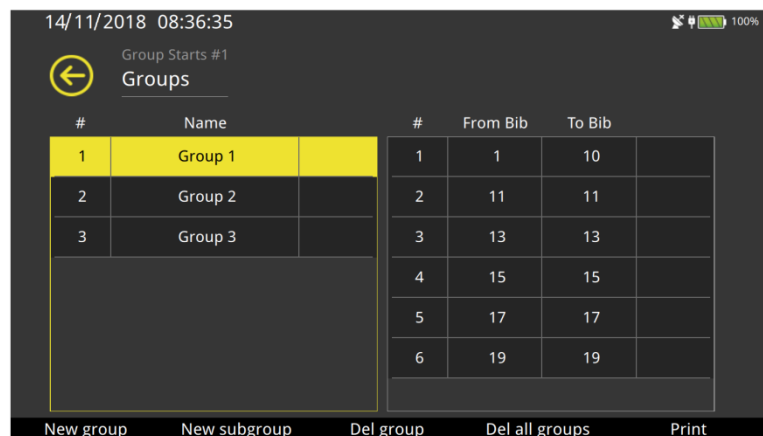

- Group 3 containing bib numbers from 21 to 30.

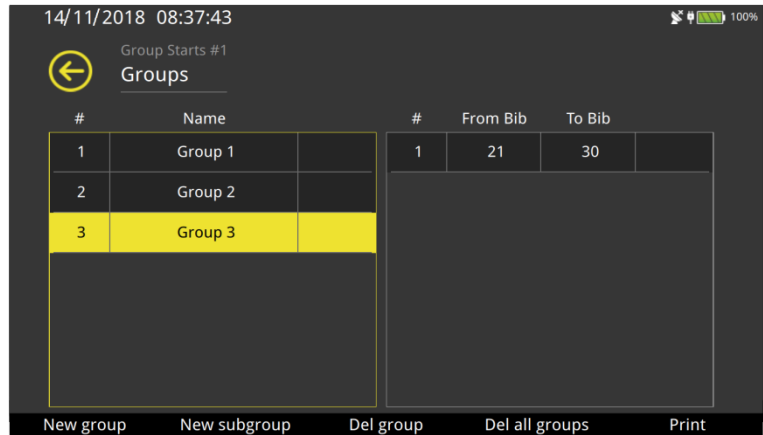

3.4.2 Group Rankings

There are various filters that allow you to print the rankings for a race with group starts. The example shows a group ranking (the accuracy is set to the second as it is configured for a marathon). See Further Details on Groups.

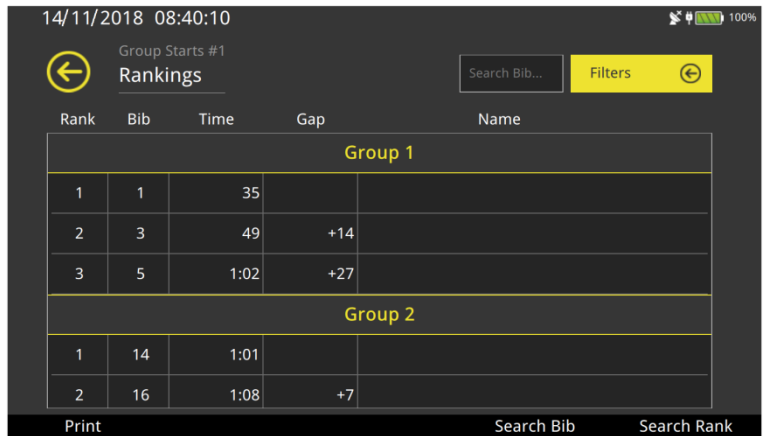

3.5 SHOW JUMPING



3.5.1 Timing Screen

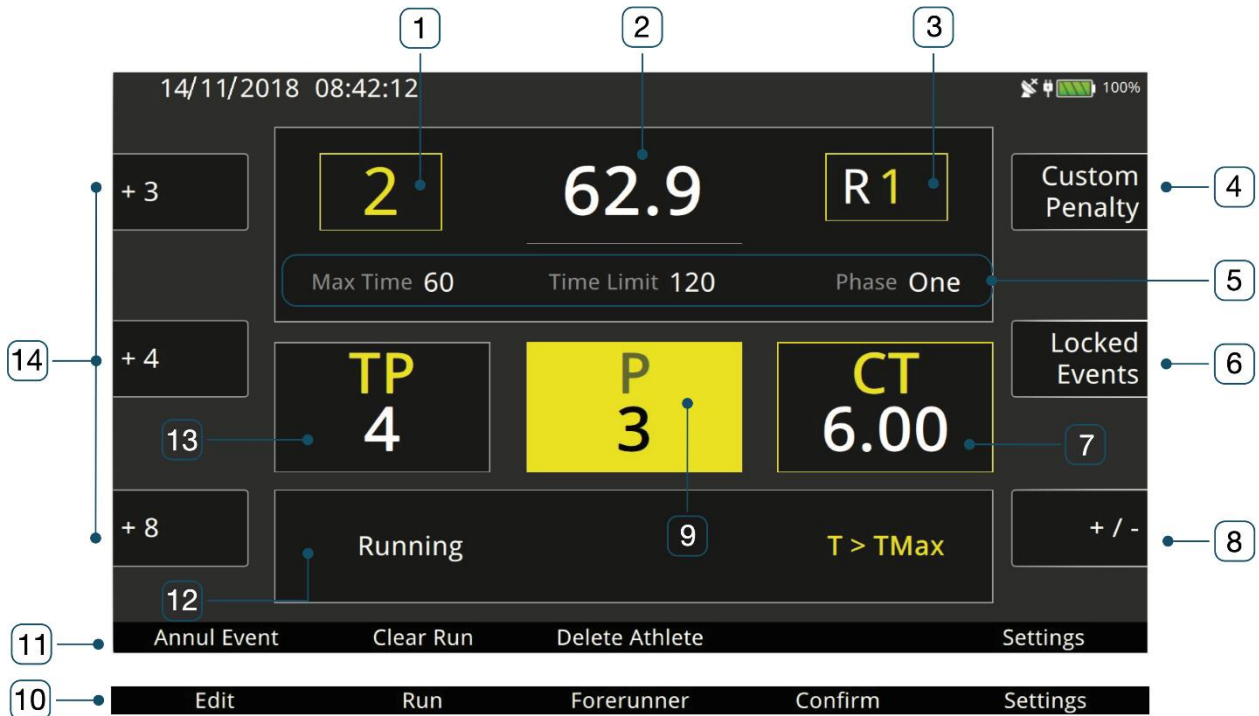

- 1- Pair number;
- 2- Running time;
- 3- Run;
- 4- Context key for manually entering the penalty/time correction;
- 5- Race setup information;
- 6- Key to show closed line events / Starting list;
- 7- Total time correction value;

- 8- +/- key for editing time penalty/correction values;
- 9- Imposed penalty value;
- 10- Function keys
- 11- Function keys;
- 12- Racing pair information;
- 13- Total penalties (imposed + penalty on maximum time);
- 14- Fast penalty/time correction keys.

3.5.2 Sequence of operations during a trial

Let's simulate a simple show jumping trial.

After choosing the show jumping program and entering the trial data, we enter the timing part.

This is the timing window, as yet without any information. Note that you can see the default trial setting without opening settings: a single phase with a preparation time of 45" and a maximum time of 60". Obviously, the pair number is 1.

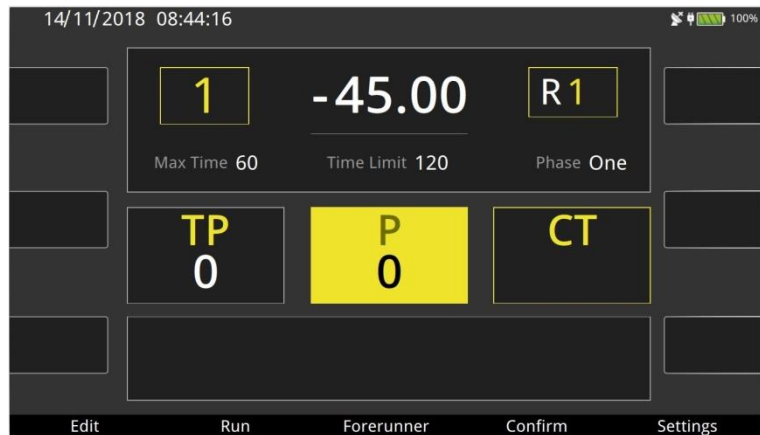

Just enter 2 from the keyboard and confirm it with ENT to populate the screen. You will see that the penalty area has a yellow background: in line with the Rei Pro interface philosophy, this indicates that some functions depend on the context of the highlighted area. In this case, the three fast keys (+3, +4, +8) correspond to penalties. **You can change the value assigned to a fast key with a long touch.**

The pair is not yet ready to start. There are some trial management tools at your disposition, but they will not be available while a pair is on the course: Edit and Memo.

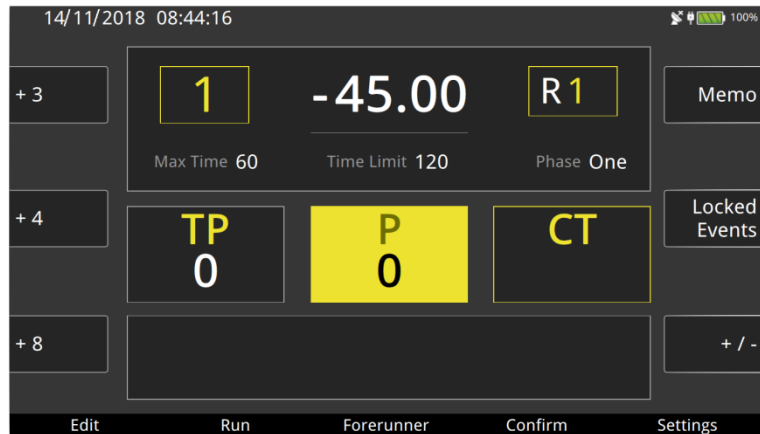

As soon as you are sure of the pair number on the field, press Confirm [F4] to enable the number. The trial management tools will no longer be available and focus will be on the current competitor. You can already enter penalties, but no time corrections as the time has not started yet. You can also delete the competitor and use the Clear key [F1] to return to the previous visualization. With the ALT key pressed, the Locked Events [E] key becomes Starting List, which lets you choose the starting pair directly from the list, if it is there.

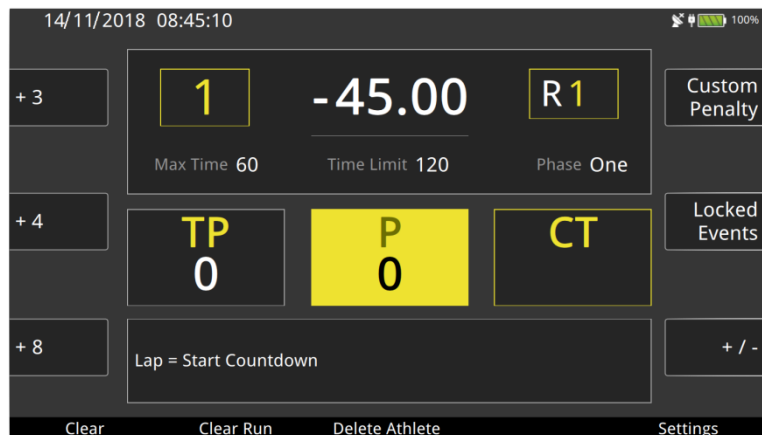

As soon as you give a Lap impulse, the preparation time will start. A second Lap impulse will interrupt it, and you can use the Delete Event [F1] key to reset it to its initial value. Note that the Delete Event will delete the last event received; if you stopped the countdown beforehand, you must first delete the second Lap and then the first to reset it to the initial value of 45".

When a Start impulse is received, the preparation time will be interrupted (the value will be given in the printout) and the trial time will start running. You can enter penalties by selecting the penalty area, as shown in the figure, and choosing one of the three fast options, or manually entering the value in Custom Penalty [D].

You can also make corrections to the time by selecting the corresponding area and choosing one of the three fast options, or entering the value in Custom Time Corrections [D]. The Annul Event [F1] key lets you annul the start event. The annulled event is not lost; you can find it in the Edit page and restore it.

An impulse on the Stop line will stop the time for the pair. You can make time corrections or add penalties during this phase. You will also have an idea of the ranking of the pair that has just arrived. In the event of an error, you can Annul the Stop event, and you will see the time continue running. Press the Confirm [F4] key to start printing the trial data for the pair that just arrived, and the next pair will appear on the screen, ready to start.

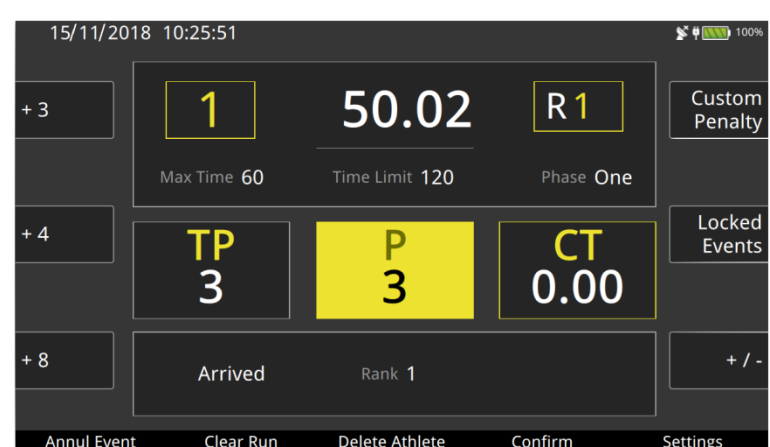
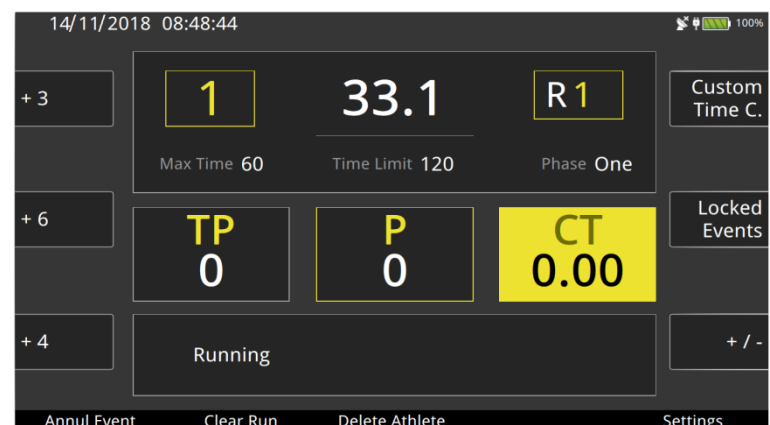
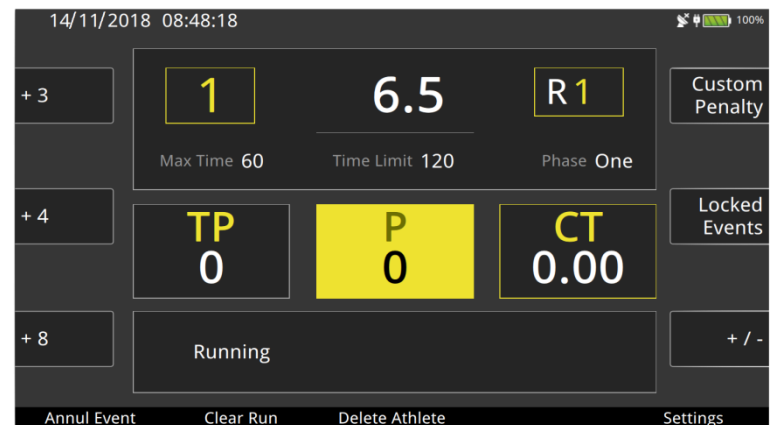
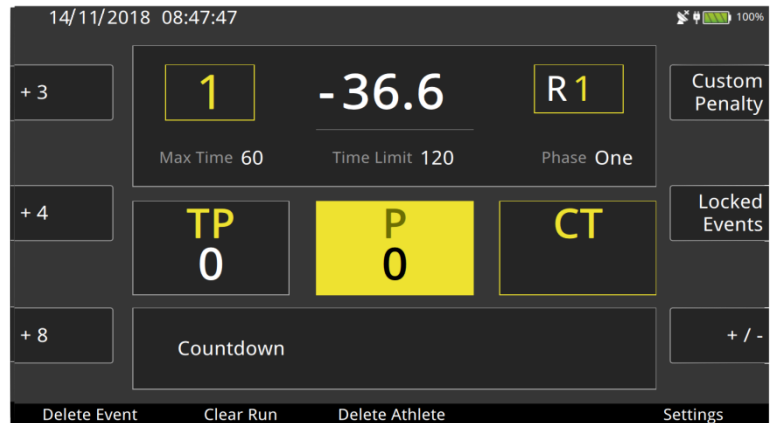

3.5.3 Edit

As for all the other timing programs, you can use the edit tool to manage all the events acquired during the trial, as well as to create new ones.

#	Bib	Time	Logical	Physical	Run P
7	1	08:49:33.14_40	STOP	Line Stop	1 1
9	2	08:49:40.13_70	START	Line Start	1 1
10	2	08:49:46.24_30	STOP	Line Stop	1 1
12	3	08:49:53.30_30	START	Line Start	1 1
13	3	08:49:57.80_40	STOP	Line Stop	1 1
15	4	08:50:16.43_00	START	Line Start	1 1
16	ANN	08:50:30.73_40	STOP	Line Stop	1 1
17	4	08:50:38.57_20	STOP	Line Stop	1 1

3.5.4 Memo

The Memo tool lets you see all the trial information for a specific pair without having to search for it in the printout.

14/11/2018 08:52:07

Show Jumping #2

Memo

Bib Number: Run:

1 **81.75** **R1**

T > Max Time Max Time 60
Phase One Time Limit 120

TP 9 **P 3** **CT 0.00**

Print Set Penalty Set Time Correction

3.5.5 Settings

Using the corresponding key, you can directly open the settings menu, which is structured in the following way: initially you define the trial type (e.g. consecutive phases), then you move on to defining the properties of the individual phases (e.g. maximum time and penalty). Finally, you define everything related to the whole trial, in a more transversal manner, such as deleting the pair after first phase, ordering the ranking or changing the time visualization on the display board.

14/11/2018 08:52:53

Show Jumping #2 → Settings → Reipro Settings

Software Configuration

Phases & Signals Settings Penalty & Times Settings General Settings

Print Configuration Send Configuration

3.5.6 Simplified trial configuration

In the Reipro, the phase settings menu lets you configure the show jumping using schematic representations that depend on the various settings.

14/11/2018 08:53:53

Phases & Signals Settings

Track configuration

End of first phase: AUX

End of trial: STOP

Back Next

3.5.7 Locked Events

The Locked Events list displays events that are locked with the LCK key.

To manage a locked event, press and hold (or double tap) the corresponding line.

3.5.8 Route types

Function	Radio signal	Input line
Start of start countdown (if applicable)	Lap E	Lap
Horse start	Start	Start
End of trial (configurable signal)	Stop or Start	Stop or Start
Intermediate time, only in “single phase” mode or the second phase in “2 phases” mode or “Consecutive Barrage” mode	Lap 1	Aux
Finish of phase 1 and start of second phase, only in the “2 phases, progressive time” and “2 phases, separate times” modes (configurable signal)	Lap 1 or Start or Stop	Aux or Start or Stop
Start of the second phase (only for the “Consecutive Barrage” mode) (configurable signal)	Lap 1 or Start or Stop or Lap 2	Aux or Start or Stop (Lap 2 is not available via cable)
Interruption and resumption of timing by the judge	Lap E	Lap

3.6 PC-ONLINE

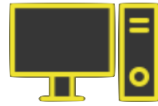

3.6.1 Timing Screen

	#	Bib	Time	Logical	Physical	Date
START Filter	1	1	08:54:54.0830	START	Line Start	14/11/2018
	2	2	08:54:58.9020	START	Line Start	14/11/2018
	3	ANN	08:55:05.5490	START	Line Start	14/11/2018
STOP Filter	4		08:55:22.5350	START	Line Start	14/11/2018
	5	3	08:55:39.5720	START	Line Start	14/11/2018

3 08:55:39.5720 START

Resend Annul Search Bib Search # Settings

The timing screen is composed of a single part, at the bottom, dedicated to the impulse that was just acquired. You can see the solar time, the logical channel and, if you chose PC-Online with bib assignment, also the box for entering the number.

The top of the screen is basically the edit screen, which you have already used in the other programs.

In fact, you can filter the impulses by logical channel, visualize the annulled events or not, edit the number, time and logical channel by simply touching the element you want to change.

3.6.2 Settings

The settings are obviously simplified, but you can choose whether or not to check for the existence of two similar events (logical channel + bib) in the race database. Therefore, you can decide to check for repeated numbers in the race, or to acquire them in any case.

14/11/2018 08:57:11

PC-Online #1 → Settings → ReiPro Settings
General Settings

Confirm time[s]: 6 Number of repetition: 20 Check events: No

Send only events with bib number if time to refresh list view[s]: No 5

3.6.3 Vintage cars

With the vintage cars configuration, you can easily manage a sequence of detections, for example in a reliability trial.

Two available configurations: Multi tubes or Single tube.

3.6.3.1 Multi tubes

Connect the first detection to the Start line, the second to the Stop line and the following ones to a LinkPod connected to the Rei Pro. When you enter the competitor numbers for the first detection, the timer will correctly assign each pass of the correct competitor, and will also recognise the pile from the second axle (which will be saved and printed, but not associated with a number). This means that you can have several competitors in the trial, and handle only the input sequence at the first detection. Moreover, you can use the Show Stations key to get a clear idea of the cars on the track. You can also edit the sequence of detections after the first one by holding down the ALT key and using the arrows to move the selected line up or down. It is also possible to declare a machine as not arrived by double clicking on the relative line.

As stated before, the Rei Pro associates all impulses received (within the confirm time you set) from the same line to the same bib. On one hand this behaviour simplifies your life when the competitors are all well spaced out and there are no disturbances, on the other hand, however, it could be inconvenient in frenetic situations during the race as you may not be able to handle the events received within the confirm time, but only edit them afterwards. In such situations, the Rei Pro offers you a fast solution: the band cut. To enable the band cut, just press the Holdoff key for the line on which an impulse is expected, and the next signal received will be considered a separate impulse, allowing you to assign a bib number or annul it if necessary. For example, suppose that the Rei Pro is connected to a single tube on the Start line and that the car number 1 is approaching it. You will have typed the number and confirmed it, but just as number 1 is about to pass the tube, car number 5 arrives at speed, just behind car 1 and passing over the tube immediately after it. In this case, the Rei Pro will associate the first impulse received with number 1, followed by the other three (rear axle of number 1 and the two axles of number 5) without giving you the chance to assign a number. To avoid this problem, just press the Holdoff key for the Start line after car number 1 has passed, but before number 5 does. The Rei Pro will then ask you to associate a number with that impulse (the third detected) and you can correctly associate number 5, all without having to look away from the road and without the need to edit the times. Obviously, the band cut function associates a single press of the Holdoff key with the next single impulse.

Of course, you can still use the Holdoff keys for their normal function of disabling the line holdoff times simply by using them together with the ALT key.

3.6.3.2 Single tube

With a single tube, all pressure switches must be connected to the Start line.

The total number of tubes connected in series must be entered.

As Multi tubes configuration when you enter the competitor numbers for the first detection, the timer will correctly assign each pass of the correct competitor, and will also recognise the pile from the second axle (which will be saved and printed, but not associated with a number). This means that you can have several competitors in the trial, and handle only the input sequence at the first detection.

If a competitor has not finished the test and a new number is entered, you will be asked whether or not to declare that the running competitor has not finished. Therefore, with a single tube, it is not possible to have several competitors running at the same time.

3.6.4 Starts

With the start configuration, you can manage starts easily. For example, rally starts or hillclimbs.

3.7 SIMPLE STOPWATCH



In the Simple Stopwatch Program, you will find a set of very simple and intuitive configurations such as:

- Athletics;
- Athletics with Bib Numbers
- Relay;
- Carving;
- Countdown;
- Motorsport;
- Playtime;
- Cycling.

Athletics, Athletics with Bib Numbers, Relay, Motorsport and Cycling modes let you manage the event in a very similar way. You work with a screen like this, with the running time at the bottom and most of the screen occupied by the list of acquired events.

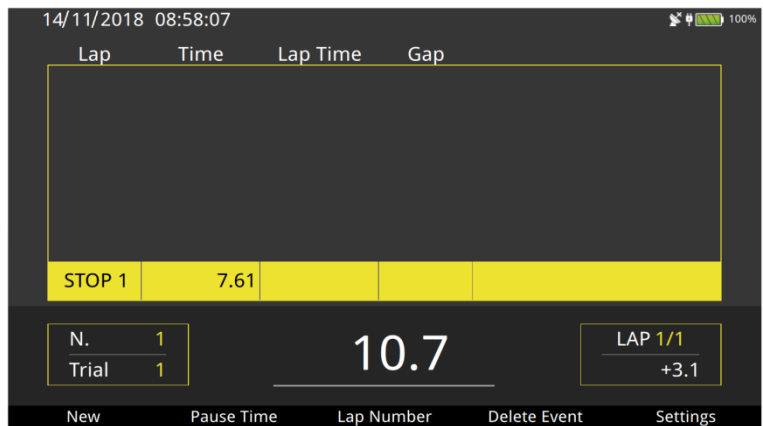

If the number of Laps is 1, the Rei Pro will acquire all the Stop events without considering the holdoff time (which is set to 40 s by default, but you can change it in settings). If, after receiving numerous impulses, you want to show the time of the first on the display board, i.e. the first impulse received, just click

Pause Time. The visualized time will stop, but you can continue to acquire impulses continuously.

Conversely, if you set a number of Laps greater than 1, the Stop line will remain closed for the set holdoff time. Its behaviour will only become the same as the case above when the last Lap is reached. In a race with multiple Laps, the Pause Time command lets you show the last Lap time received.

Concerning the Start time, you can decide whether to start the time from zero, link to the solar time on the Rei Pro, provide a starting solar time or provide an initial time.

In the case of the Athletics with Bib Numbers mode, it is possible to associate a bib number to each stop event to then be able to manage the calculation of the rankings. So it is possible to use this mode as simplified management of group starts, but taking care that there are no overlapping finishes of different groups. In case of overlapping finishes of different groups, the Group Starts program should be used.

Countdown mode, on the other hand, lets you manage a countdown, which you can hold with Stop and restart with Start. Alternatively, you can choose to start it from the configurable initial value on each Stop impulse.



3.8 SWIMMING



3.8.1 Choosing the configuration

Various configurations are available to handle the numerous kinds of timing measurement needed for racing in lanes:

- Manual: manual detection (single);
- Automatic 1 side: automatic detection (touchpad + manual) from one side only;
- Automatic 2 sides: automatic detection (touchpad + manual) from two sides;
- Automatic 2 sides + start: automatic detection (touchpad + manual) from two sides and false start;
- 3 Manual 1 side: triple manual detection for each lane from one side only;
- 3 Manual 2 sides: triple manual detection for each lane from two sides;
- Rowing: single detection with the option of multiple Laps along the course;
- Rowing no numbers;
- Climbing: single detection with Laps, but limited to a maximum of 4 lanes.

3.8.2 Session settings

The next step is to provide the Rei Pro with the features of the race course. You can set the number of physical lanes, pool length and position of the timing table with respect to the racing direction and more. Obviously, you will only be asked for all of this during the race creation phase, but you can always edit the data entered at any time.

3.8.3 Race settings

Once you have explained the course structure to the Rei Pro, you can set the properties of the race session: the race distance, which together with the pool length you set earlier will determine the number of laps; the touchpad rearm time after an impulse, and all other racing information.



3.8.4 Timing screen

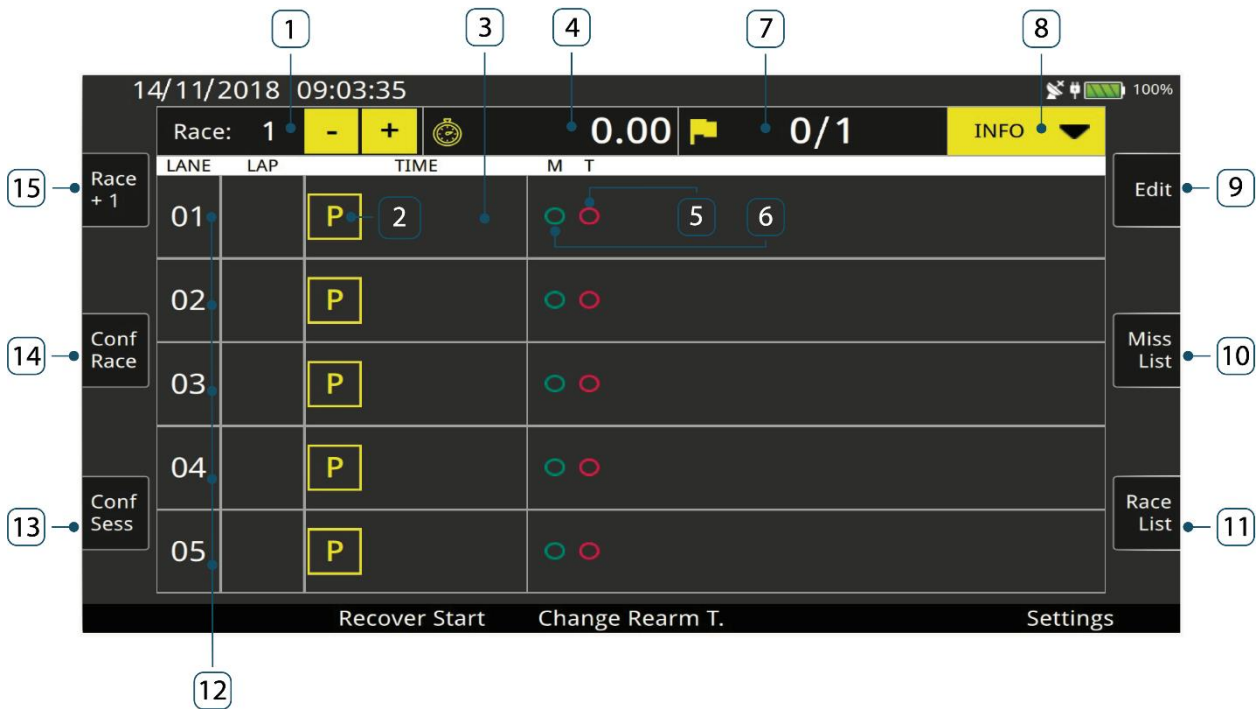

1. Progressive race number with management buttons;
2. Lane status icon;
3. Lane time area;
4. Race time;
5. Touchpad status icon;
6. Manual status icon;
7. Current Lap indicator;
8. Fast menu for race configuration data;
9. Edit;
10. Missing list/Time list;
11. Race List;
12. Line lines;
13. Session configuration;
14. Race configuration;
15. Create new race.

3.8.5 Race flow

Suppose you have created a swimming race, with manual configuration and 5 lanes 50 m long. Once you have defined a 200 m race, you will see this screen.

You can see that: it is the first heat, there will be two laps and the icons in all the lanes indicate that it is ready to start.

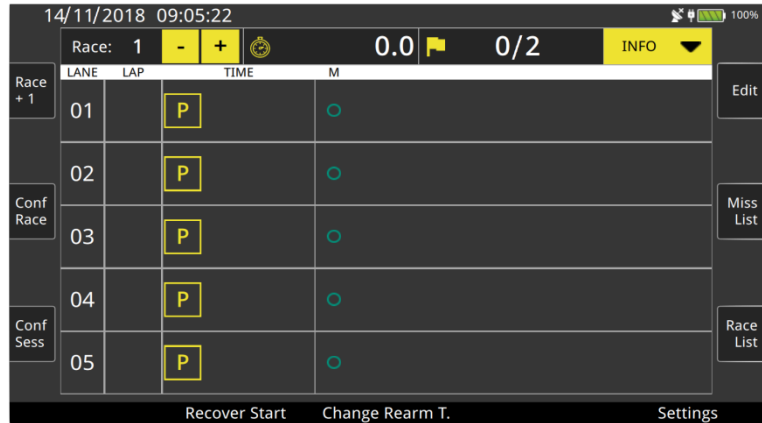

When a start impulse is received, the screen will change completely to the following: The time is running and the lane icons indicate that the rearm time you set has not yet elapsed. The Rei Pro also graphically shows you the hypothetical direction of the competitors. The Recover Start key lets you use any of the start impulses received previously.

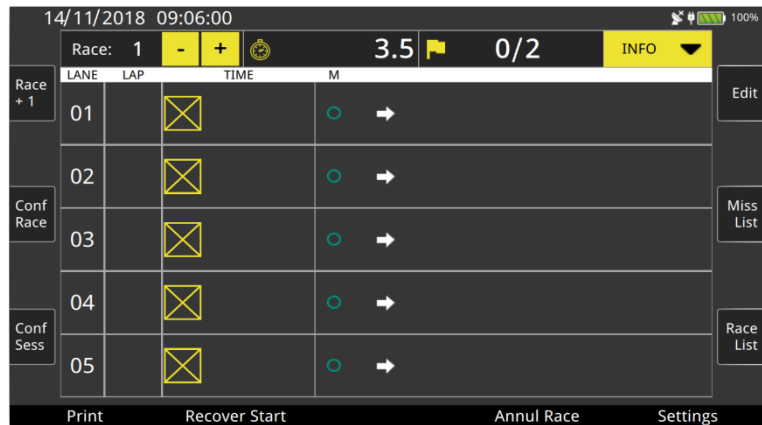

When the reset time has elapsed, the lane closing icon disappears and the Rei Pro shows that the athletes could be approaching for the first impulse.

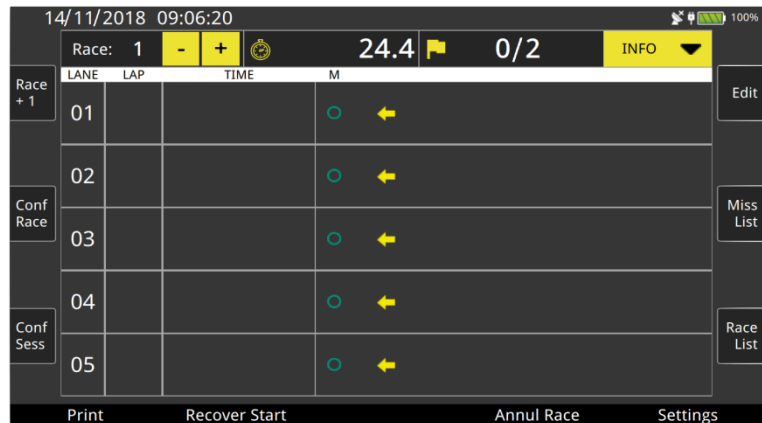

When impulses have been received for all the lanes, the timer shows this: lanes 1, 2, 3 and 4 are already rearmed and ready to receive the arrival impulse (the two concentric squares indicate that the next impulse will be the last), while lane 5 is still closed and shows the time of the first impulse. In this case, the Rei Pro will show a race forecast based on the times of the first length. Moreover, you can touch the Missing List button to see all the race lap times.

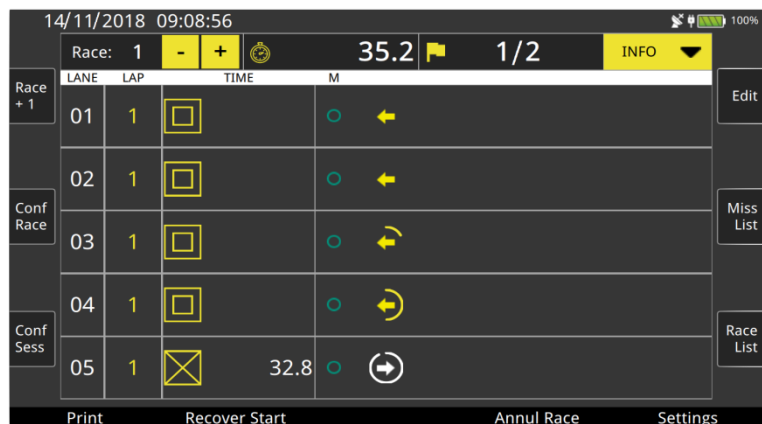

The first three lanes have finished the race, indeed the timer shows the finish times and the finish order. Lanes 4 and 5 are still running and the rearm time has already elapsed.

When all the athletes have finished and the official result has been printed (this action officialises the race results), to prepare for the next heat, just touch the + key in the race number field or press ALT+right/left arrow to increase/decrease the race number. The Rei Pro will create a new race with the same properties as the previous one.

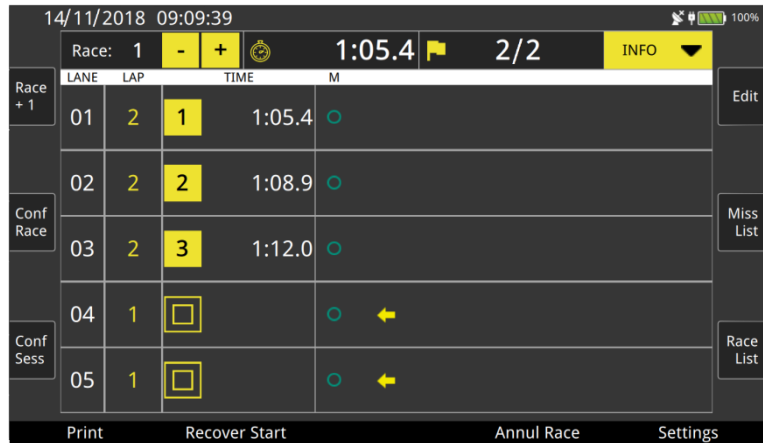

Alternatively, touch the Race List to open the screen with a list of all the races run up to the current time, including the status and properties of each one. Obviously, you can also recall any of these races.

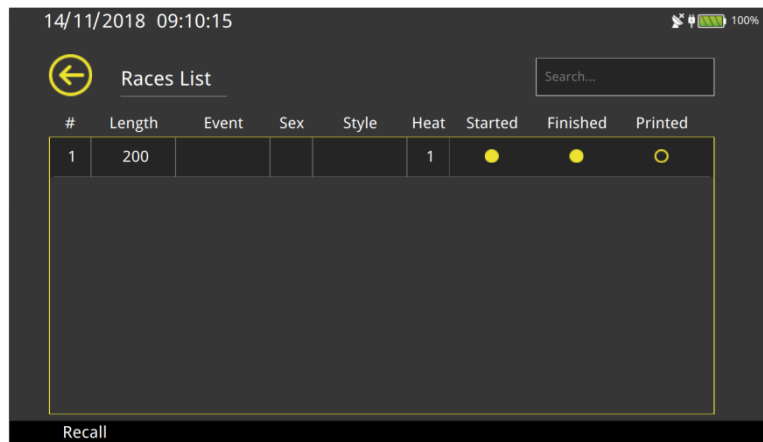

3.8.6 Dual touchpads and starting blocks for false starts

In the previous example, you created the simplest kind of race among the configurations. Now you can move on to the most complex: create a race with automatic detection on both sides and with starting block management for false starts. The course in question will have a pool that is 50 m long with 5 lanes, while the next race will be 400 m. When the start impulse is received, the following screen will appear: you can see that two touchpads are shown for each lane, while there are manual and touchpad icons at the centre of each lane. In this case, the arrow accurately shows the athlete's direction.



If a false start is detected, the timer will highlight the event on the printout.

For each Lap, the Rei Pro will wait to receive an impulse from the touchpad, together with the corresponding manual impulse. As it may not always receive both, the timer will validate the only impulse it received after a certain (programmable) time, i.e. it will create the missing impulse by duplicating the one it received. Obviously, everything will be visualized on both the printout and the edit page.

The race management will be exactly like the one seen earlier, differing only in that twice as many impulses will be received.

3.8.7 Settings

Depending on the configuration you choose, you may have only some of the settings that are available for the more complex races. For automatic timing with false start detection, the following will be available:

- Advise difference: you can decide a time tolerance, and a warning of excessive difference between the touchpad impulse and the manual impulse will be visualized if it is exceeded. Obviously, the printout will show the lane in which the event occurred;
- Manual/touchpad impulse after: if only one of the two impulses is received for a lane, after the set time, the timer will use the only impulse received to replace the missing one;
- Time to refresh list view: This shows the time after which the last event received will be inserted in Edit and Fast Edit (it is disabled if set to zero);
- False start: you can decide the time interval before or after the start, outside which the starting block impulse is shown as a false start.

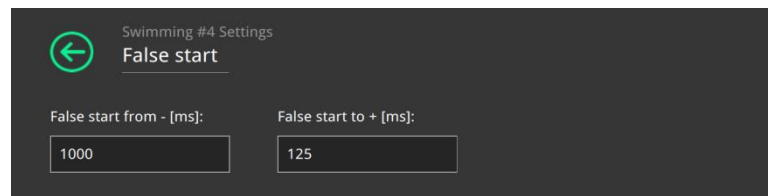
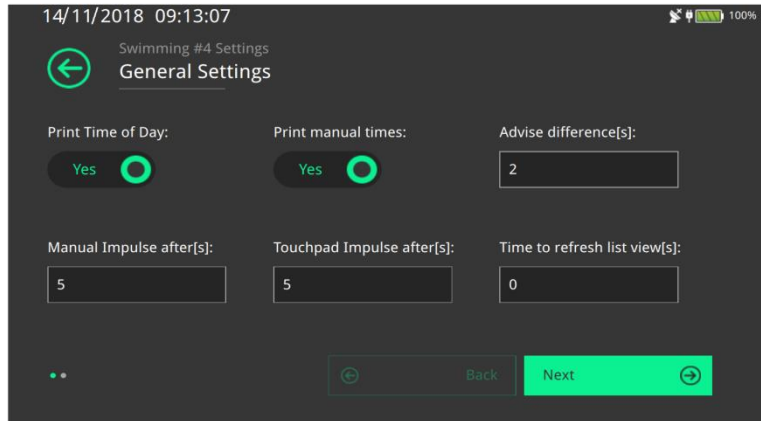

3.8.8 Screen shortcuts

The Rei Pro lets you make changes to the race very quickly and conveniently, without the need to open a configuration menu. In fact, the bar at the top of the screen does not just describe the race data, but it can also be edited. This means you can change the values visualized.

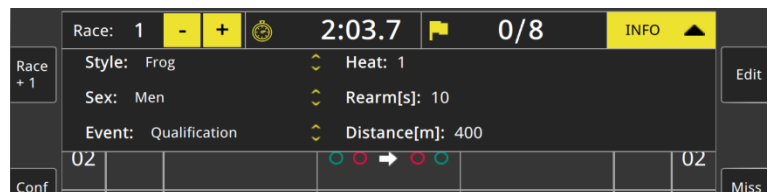

Specifically, you can:

- Enter a Start solar time by simply touching the clock icon and typing the value you want;
- Increment the race number using the + and - keys;
- Change the expected number of impulses by touching the flag (the race length will change automatically);
- Change the race data by touching Info and editing the data visualized.

You can also make changes to each individual lane. Once you have selected a lane by touching it or typing its number, you can lock, disqualify or annul either the touchpad or manual impulses. Just press ESC to exit from the lane selection.

3.8.9 Rowing

The "Rowing" configuration is suitable for rowing competitions where each lane is associated with a button.

The structure is similar to swimming. In rowing, however, there may be more than one heat, so during one heat, the START pulse can be received to signal the start of the next heat. The reset time is used to establish which heat a particular event is to be associated with. In this case, the reset time serves to determine the time available for the reception of events for all competitors in this intermediate stage. Let us suppose that the first contestant crosses the finish line, then the next events will be associated with that heat only if they cross the line before the end of the reset time, otherwise the pulses will be associated with the next heat, if it has started. You therefore need to set the reset value in accordance with the specific characteristics of the competition.

3.8.10 Rowing with no numbers

With this configuration, events are acquired solely from the stop button/line. Events are printed immediately without the lane number. You can still match the event to the lane via Edit or Fast Edit

3.9 PARALLEL



3.9.1 Timing screen

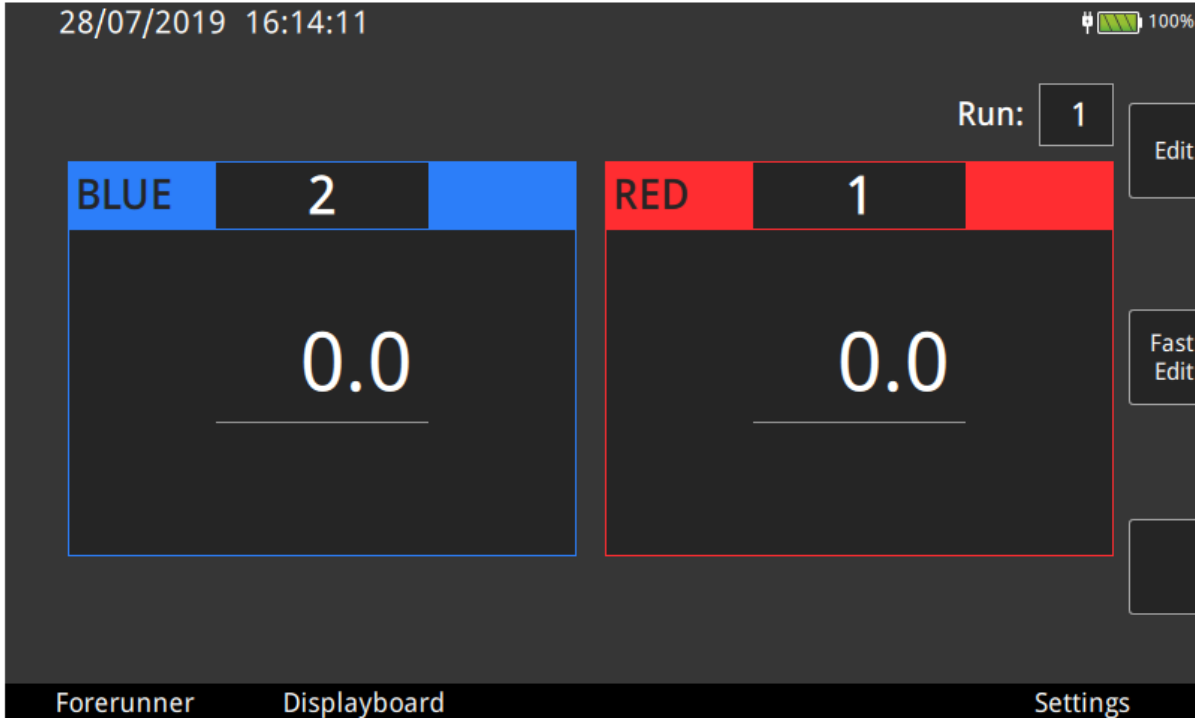

timing screen is divided into two zones, each dedicated to one of the two competitors in the race. The two detection lines are identified by the colours blue and red. When connecting the systems for detecting the two routes, you will need to assign a colour to identify a specific finish line. In other words, you will have to match each of the two “physical” paths to the two “virtual” paths, i.e., the ones displayed on your ReiPro screen. The competitor's race time and the gap at the finish will be displayed inside the two areas.

3.9.2 Race flow

To familiarize yourself with the program, choose the Rally configuration from the various proposals. On first entering the timing screen, ReiPro will ask you the number of the current round, pressing the enter key will automatically switch to assigning the bib on the red track and then the one on the blue track.

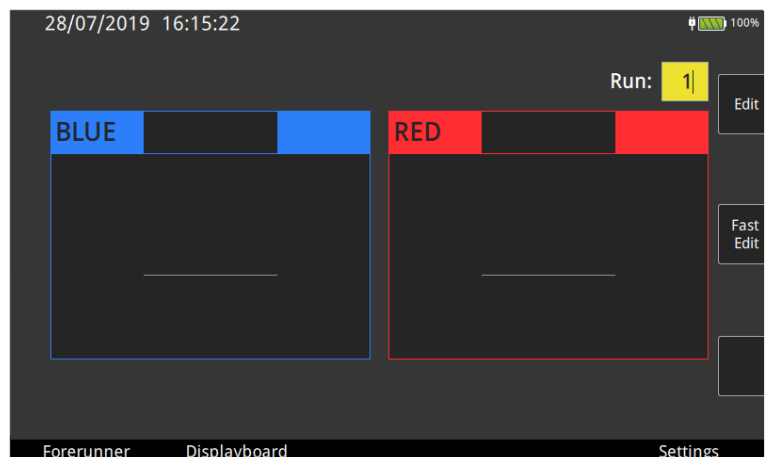

The stopwatch is now waiting for a start impulse. If there are any forerunners, which therefore are not to go into the rankings, simply select that mode using the F1 key. You can also give a number to the latter, which will be differentiated from the others by the letter A before the number (e.g. A1, A2, etc.).

Assuming you go straight into the race, once you have received a start impulse (in Rally mode the start impulse applies to both competitors) the time will start running. As you can see from the function keys, you can cancel either start (or both), you can also delete one of the competitors (or both, again). In the event of an error in this phase, you can re-enable the single impulses from the Edit menu, which we will see later.

After receiving the stop impulses from both tracks, you will see the two times and the gap of the second competitor to finish. You can then confirm or cancel the trial. In the former case, ReiPro will ask you for a new pair of bibs, while in the latter case it will stay on the bibs that have just competed, cancelling all the impulses associated with them.

3.9.3 Edit

The Edit page, as in the other programs, allows you to manage all the received impulses completely.

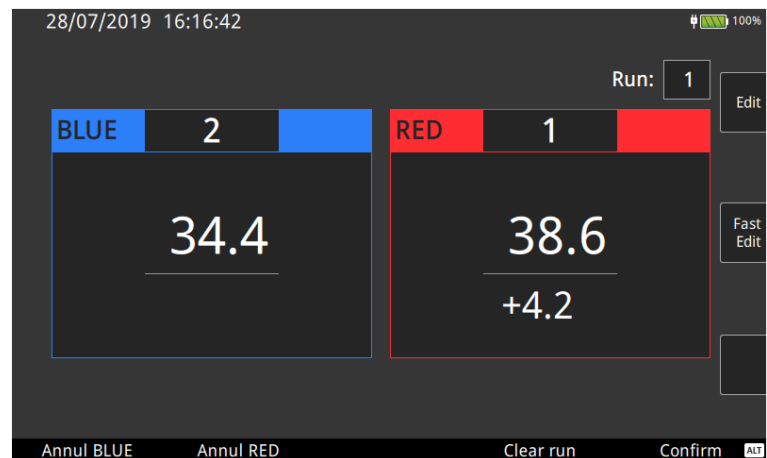
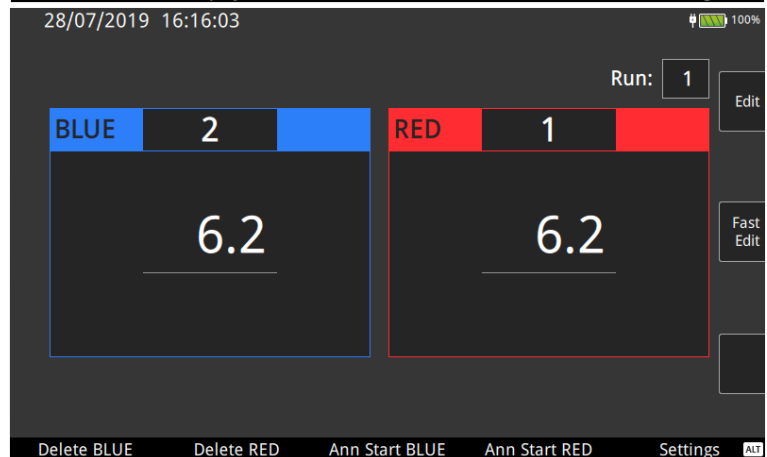
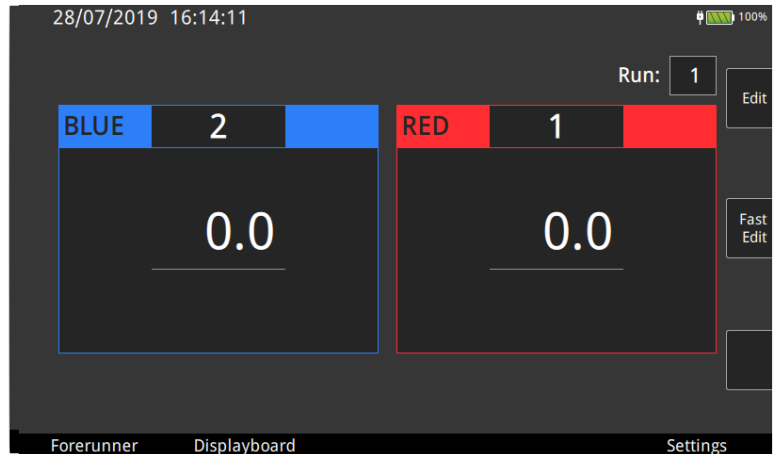

#	Bib	Time	Logical	Physical	Run
1	1	16:15:57.6_030	START	Line Start	1
2	2	16:15:57.6_030	START	Line Start	1
3	2	16:16:32.0_650	STOP	Line Stop	1
4	1	16:16:36.2_230	STOP	Line Aux	1

3.9.4 Settings

You can, of course, customize the timing program with a number of options, including:

- Start mode: You can decide to have a single start for both tracks, one for each track or even none, in case you want to detect only the gap between two finishers;
- You can set a maximum gap between the two tracks;
- You can decide how to position the two colours on your ReiPro screen and on the display board, even in a differentiated way;
- You can set a number of events that, being received on the same line, will determine the final time, if the competitors perform a number of (detected) runs on the same line.

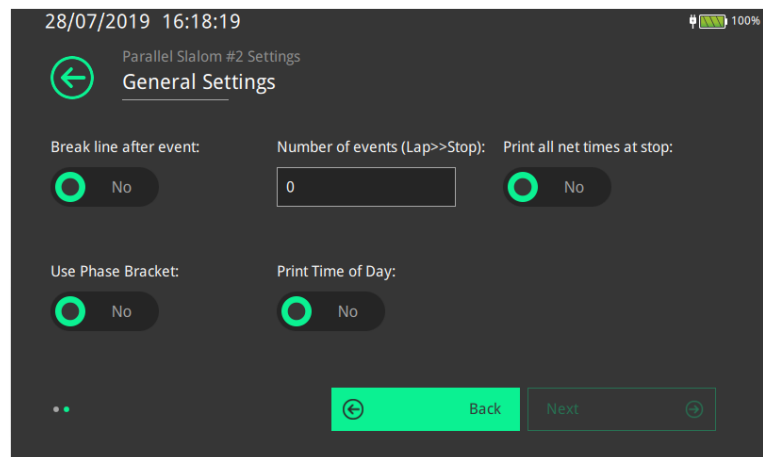
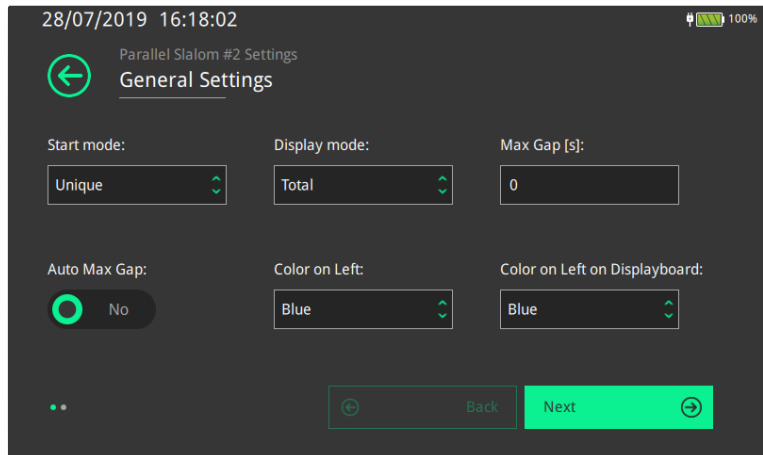

The different configurations available for the Parallel program differ only in the way in which the events are acquired, maintaining the same race management.

Configuration	Event Blue Track	Event Red Track	Channel Logical	Radio	LinkPod
Snowboard Relay	Start	-	Start	Start	
	-	Start	Lap	Lap1	
	Finish	-	Stop	Stop	
	-	Finish	Aux	Lap2	
Alpine Skiing	Finish	-	Stop	Stop	
	-	Finish	Aux	Lap2	
Rally	Start	Start	Start	Start	
	Finish	-	Stop	Stop	
	-	Finish	Aux	Lap2	
Climbing	Start	Start	Start	Start	
	False Start	-			LinkPod 0, Line 1/5
	-	False Start			LinkPod 0, Line 3/7
	Finish	-		Stop	LinkPod 0, Line 2/6
	-	Finish		Lap2	LinkPod 0, Line 4/9

3.10 PURSUIT



3.10.1 Timing screen

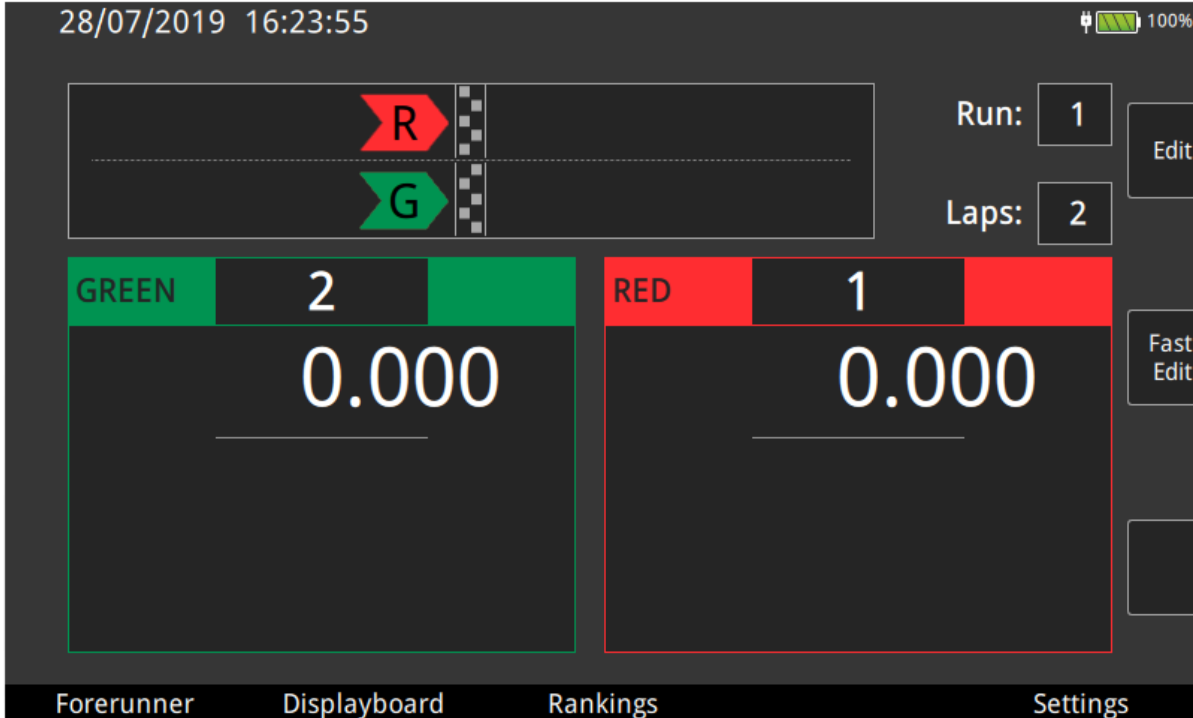

The timing screen of The Pursuit program (as well as several settings) is very similar to that of the Parallel program, with the areas dedicated to the competitors in the race, this time identified with green and red (except for the skating configuration, which is distinguished with the colours of red and white), but with the addition of a “preview” of the race situation, which changes according to the history of acquisition of the single track events. This preview reflects the physical performance of the race, i.e. two competitors competing on the same track, exchanging the finish lines over which they will have to pass.

3.10.2 Race flow

The race flow also partly follows that of the Parallel program, on entering the timing screen, after choosing the configuration (rally, also in this case, for convenience), the first information that ReiPro will ask you will be the rounds, the number of Laps that will determine the course of the race and the numbers to be assigned to the two tracks. Once you have entered all the required data, you will notice the representation of the two competitors ready to start, i.e., behind the finish line.

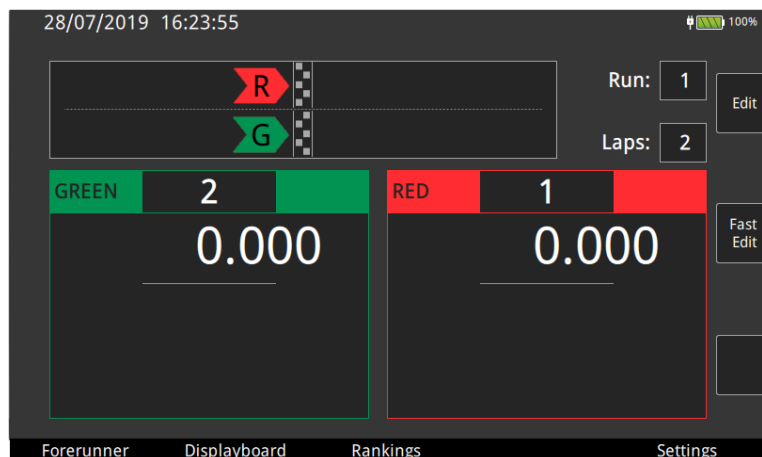

Once the start impulse has been received (also in this case, unique for both tracks), you will see the time run in the competitor boxes, but the situation of the race will also have changed. The two competitors will be displayed after the finish line. The yellow bar below the two competitors is simply a graphical representation of the reset time of the two pass-through detection sensors. Of course, you can configure the reset time as you like.

At the end of the reset time, ReiPro will show you it is ready to receive the next event, showing the two competitors arriving at the finish line. You will notice that the colours will be reversed compared to the starting colours, as each competitor will pass the other's start line.

Now let's assume that it is the red track competitor who cuts the finish line first. Following the same logic as the start, you will see the red competitor pass the finish line, while the green one (which you are still waiting for) will be before the finish line.

At the end of the red track reset time, ReiPro will show you the two competitors "queued" according to the sequence in which it expects to receive the impulses, in this case first the green latecomer, followed by the red one.

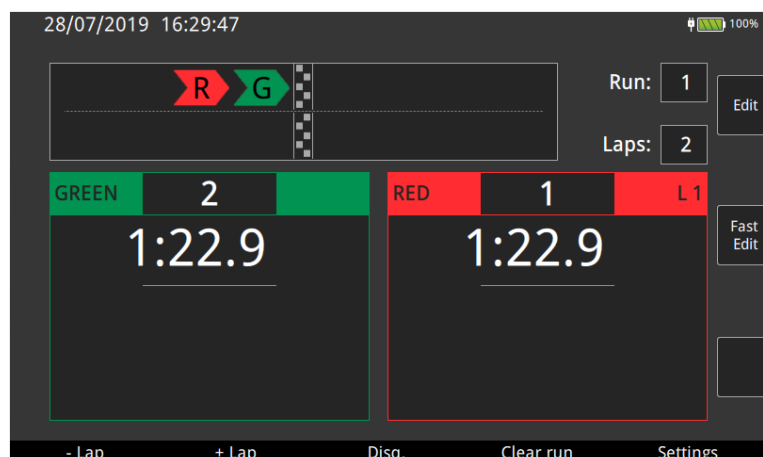
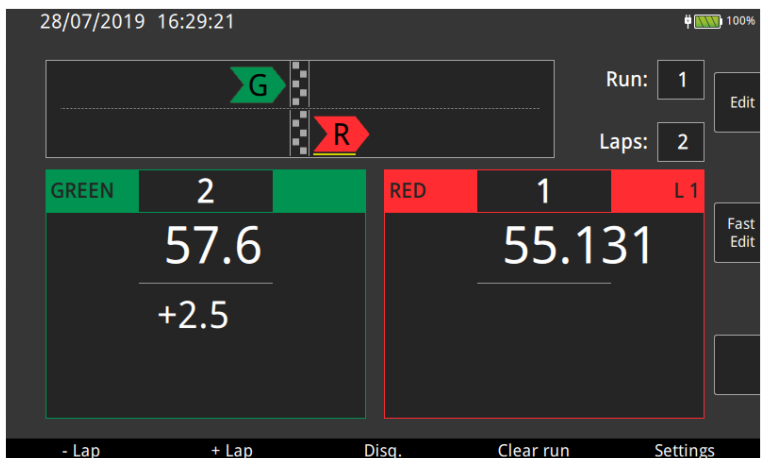
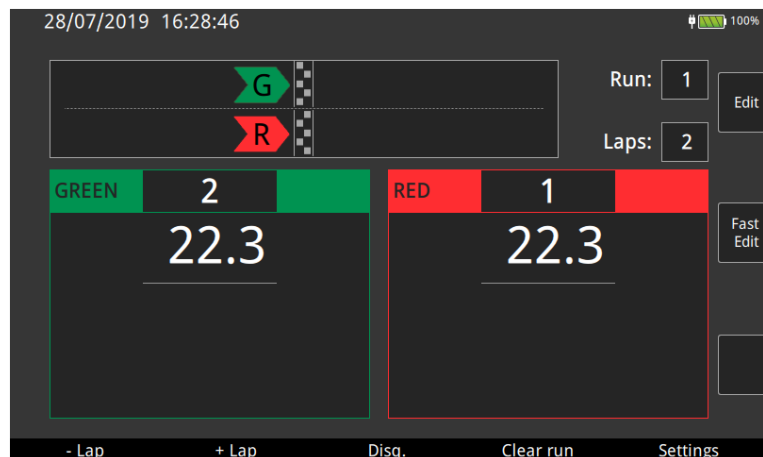
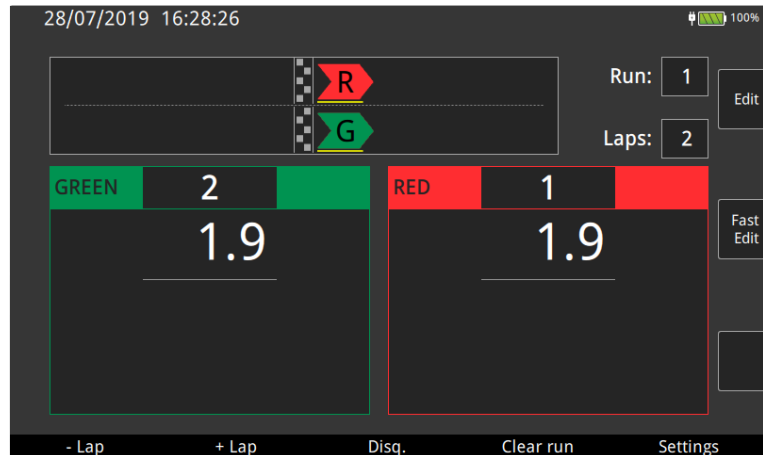

Once the impulse has been received from the green competitor, the display will always follow the same logic.

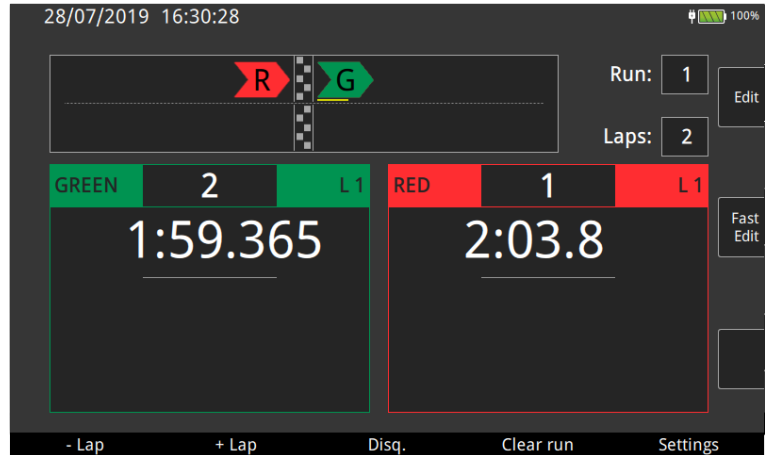

At this point, since there are two steps, ReiPro will expect to receive the last impulse for both competitors.

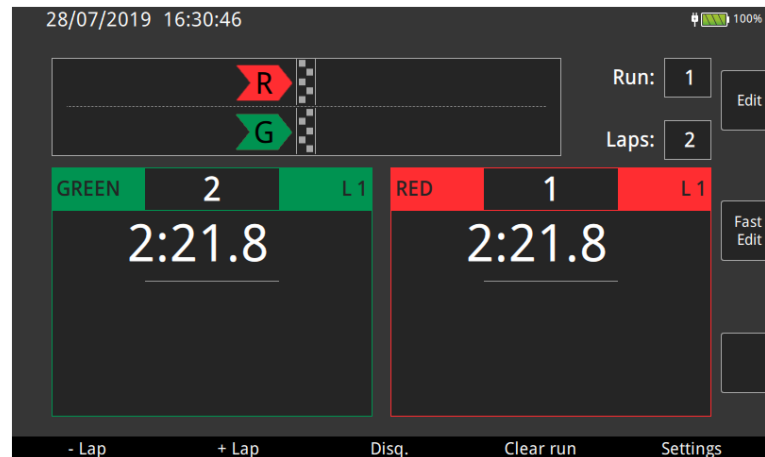

In fact, when the green competitor passes, a chequered flag will be shown, in addition to the race time.

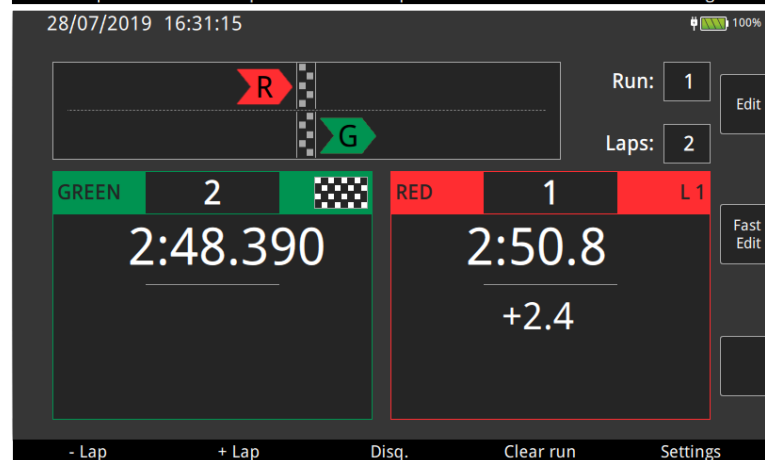

Then also for the red competitor.

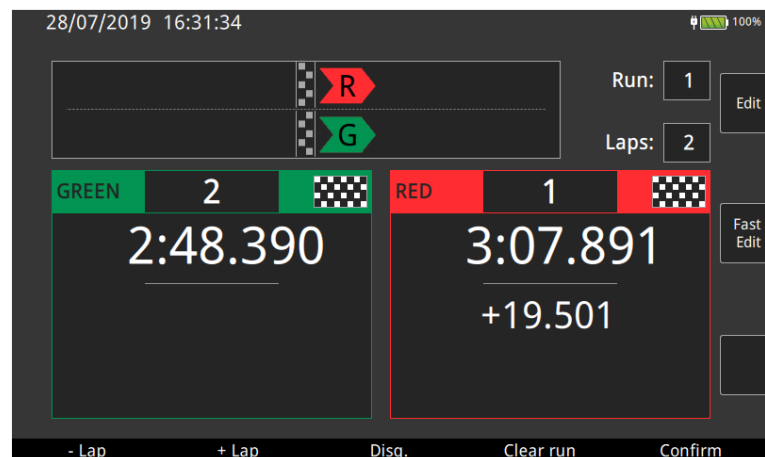

3.10.3 Race Control

The particular display of a pursuit race together with the presence of a touchscreen on your ReiPro have led to a new way of managing the race. You can put each competitor in the position he really occupies in the race, for example after overtaking or a withdrawal, by literally dragging it on the screen.

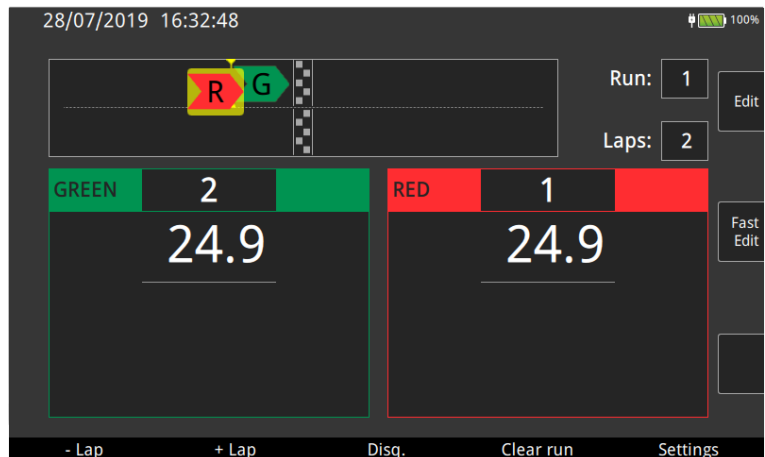

3.10.4 Logical channel assignment

The Pursuit program uses the stop and aux channels, assigning the former (stop) to the track displayed at the bottom and the latter (aux) to the track displayed at the top. This will be true whatever the colour assigned to the two tracks.

3.10.5 Quadruple Pursuit

One of the race modes available for pursuing is called “Quad”. In this configuration you will no longer have only one pair of competitors starting, but two pairs. Its management will faithfully match what you have already seen for the other configurations, the only difference will be due to the second start impulse that will start the second pair of competitors in the race.

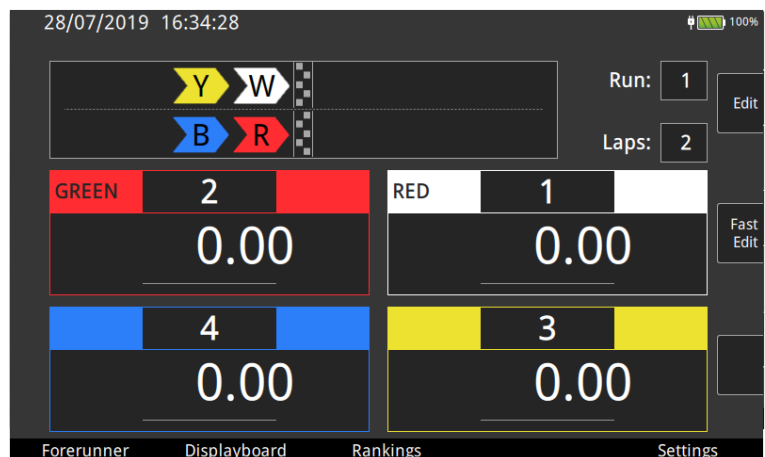

In the figure you can see one of the two pairs has already started, while the other one is still waiting for the start.

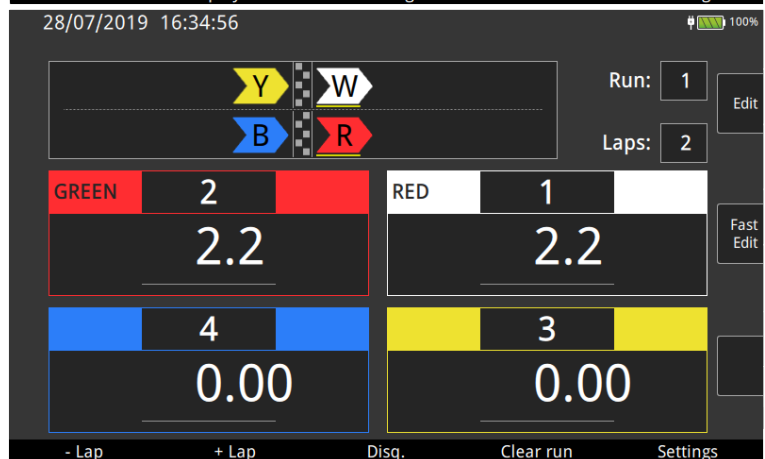

Obviously, while waiting for the second start impulse, the first pair will advance as per the program and will finish the first lap, when the second pair has just received the start.

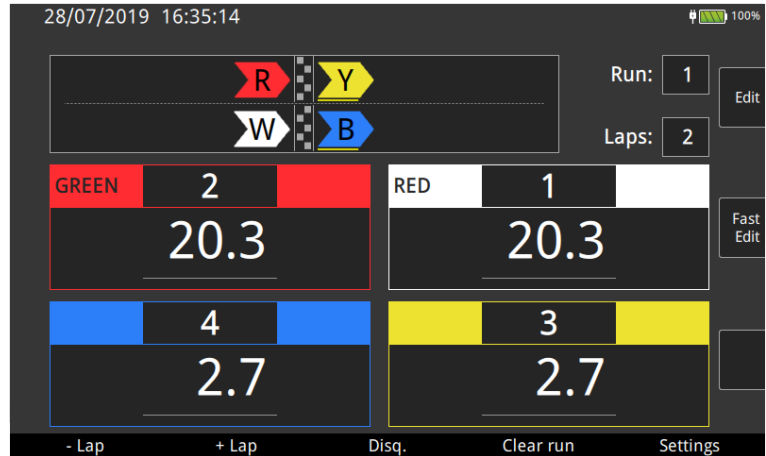

4 FURTHER DETAILS

4.1 LINES CONFIGURATION

Given that any timer is just a complex system for managing received external signals, it is logical that managing the inputs correctly is essential for the outcome of an event. The Rei Pro offers very flexible input signal configuration. To make best use of the potential that the Rei Pro offers, you must familiarize yourself with some basic concepts:

4.1.1 Physical and Logical Channels

- **Physical Channel:** a physical channel is simply a “medium” through which the timer receives an impulse. With the Rei Pro, you have: keys, lines (i.e. the sockets at the rear), radio transmission and LinkPods. Practically, each individual key, line, EncRadio setup (i.e. each EncRadio set up differently from the others) and LinkPod contact will be a physical channel.
- **Logical Channel:** while the physical channel is the physical medium of the signal, the logical channel is the “meaning” that you attribute to a specific physical channel. These “meanings” correspond to Start, Stop and a multitude of Laps.

In other words, each physical channel will be converted into the logical channel you have assigned to it.

Considering this, the function of this screen will be obvious:

We are in the page for assigning logical channels and keys to the lines. Obviously you cannot edit the physical channel. What you can edit, using the drop-down men, is the “action” that you want to link to a specific logical channel. In the screen to the side, the selected menu is for choosing the logical channel to associate with the physical channel of the Start line.

In the physical and logical channel assignment menu, you will find two similar pages for the Radio and LinkPod channels.

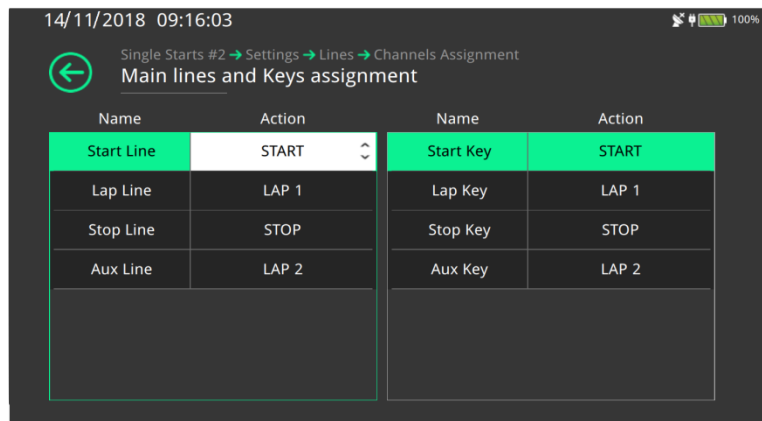

4.1.2 Lines holdoff times

For the outcome of an event, it is equally important to set the holdoff times correctly. The line holdoff time is the time interval after an impulse during which the line remains disabled. In other words, when a signal is received on the Start line, for example, that line can no longer receive impulses for a certain period of time. This period of time is the holdoff time, which is configurable. In fact, touching the corresponding entry in the lines configuration menu will open this page:

Just touch the cell that corresponds to the line you want to configure and type the time you want to set, in milliseconds. In the example to the side, the holdoff time for the Start line is being edited.

But be careful, because the timer will not receive any signals during the holdoff time. Although this statement is true, Rei Pro still provides an option. In fact, the Holdoff key has serves to reset the holdoff time, making it possible to acquire two events that are very close to each other.

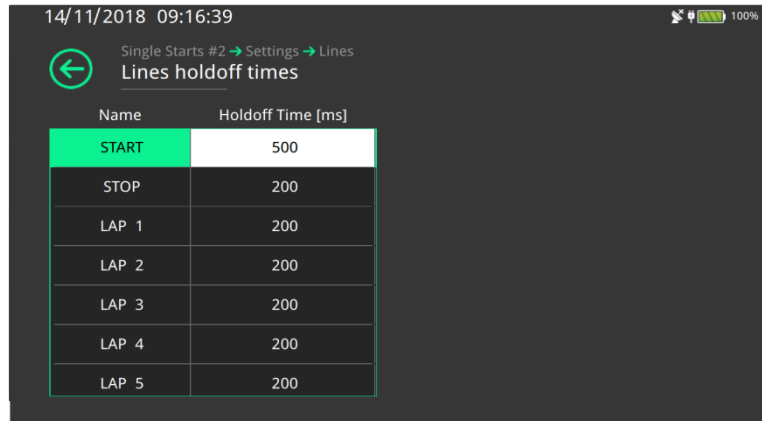

4.1.3 Lines exclusion configuration

Another option that the Rei Pro offers is the ability to configure how the line exclusion keys work. For example, you can also associate the Start line key with a Lap exclusion.

In this screen, locking the Start and Lap 1 lines has been associated with the LCK START button (by selecting the drop-down menu at the top right).

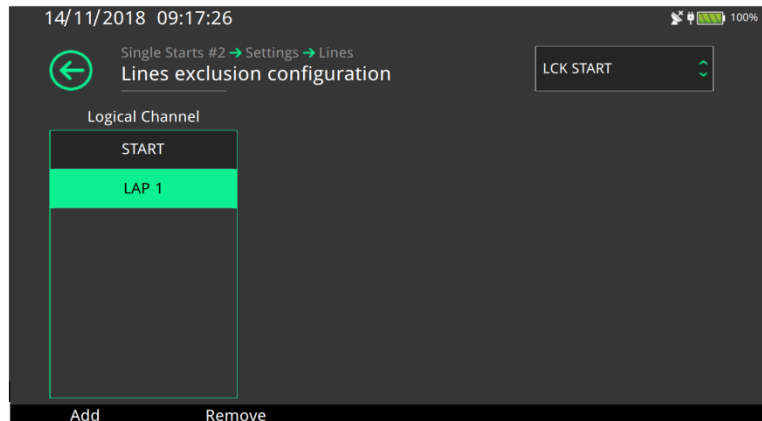

4.2 MANAGING GROUPS

For both single starts and group starts, creating groups in a “smart” way can simplify your life when managing a race and its rankings.

We begin with two basic premises: the same competitor can belong to more than one group at a time. In fact the Rei Pro does not check the uniqueness of the group compositions.

Moreover, the groups are identified by a number that also determines their importance: the lower the group number, the greater its importance. In fact, the Rei Pro calculates the ranking by searching for the specific competitor in the groups, starting from the group with the lowest number.

If the groups were created in the wrong order, meaning assigned the wrong value that determines their importance, you can move the groups up or down as you like. To do so, just select the group to be repositioned, hold down the ALT key and use the arrows.

An example will clarify everything.

Create four groups:

1. Junior:
Bib numbers from 1 to 10, plus number 31;

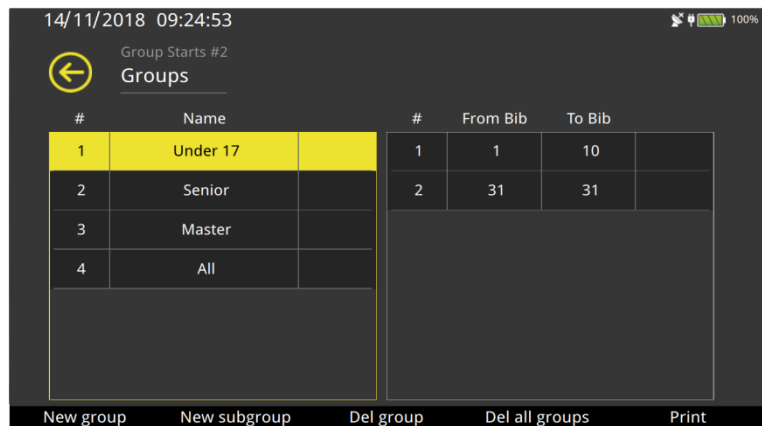

2. Absolutes:
Bib numbers from 11 to 20;

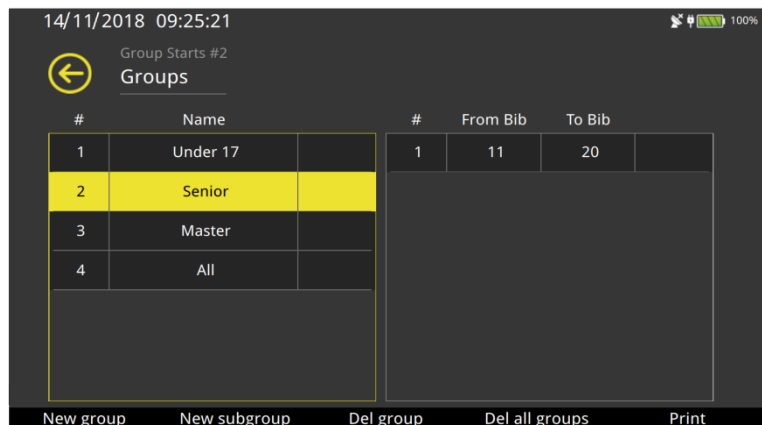

- 3. Master:
Bib numbers from 21 to 30

14/11/2018 09:25:42
Group Starts #2
Groups

#	Name	#	From Bib	To Bib
1	Under 17	1	21	30
2	Senior			
3	Master			
4	All			

New group New subgroup Del group Del all groups Print

- 4. Total:
Bib numbers from 1 to 31

14/11/2018 09:26:06
Group Starts #2
Groups

#	Name	#	From Bib	To Bib
1	Under 17	1	1	31
2	Senior			
3	Master			
4	All			

New group New subgroup Del group Del all groups Print

Basically, you have 3 completely distinct groups and one group that contains all the athletes together, so each athlete will be in two groups: that of the category to which he or she belongs, and the general one.

Suppose that Junior, Absolutes and Master start together, i.e. with the same Start, but the rankings will obviously be done separately.

At the start, you will start group 4. That means that you will assign the same start time to all the athletes. Groups 1, 2 and 3 will have no start time, but the bib numbers within them will, as they are also in group 4. When we show the arrival times for the individual athletes, the ranking will not refer to group 4, but to the first three groups (all with a number less than 4, and therefore more “important”).

4.3 “PHILOSOPHICAL” DIFFERENCES BETWEEN PARALLEL AND PURSUIT

At first glance you may not see many differences between the Pursuit and Parallel programs, but there is a difference and it affects both the management of the race with your ReiPro and the physical preparation of the race, although both can be run on the same type of route. In the Parallel program each of the two detection lines is assigned to a specific competitor, then the one connected to the stop line will be related to the blue track, while the one connected aux will be related to the red track (taking the example race shown in the part related to the Parallel program). You must be the one, by appropriately switching off the single lines, to correctly manage incoming impulses (you will simply not have to detect the blue competitor passing on the red line and vice versa). The set Laps, too, will always be related to the same line, that is they will be whole laps of the route. Otherwise in the Pursuit program the two competitors will continue swapping over detection lines until the end of the race and, if the number of laps is odd, each competitor will finish where the other one started. Therefore the stop and aux lines will not always be related to the same competitor, but will physically identify the two detection lines. That is, an impulse on the stop line will be first assigned

to one competitor and then to the other one, and this is precisely the particularity that makes the graphical display of the race implemented in the Pursuit program extremely useful.

5 ANNEXES

5.1 TECHNICAL

GENERAL	
Weight	2.2 kg
Dimensions	365 x 245 x 78 mm (78mm max, 30mm min)
Operating temperature	-25/+70 °C
TIMING	
Time measurement unit	Selectable 1s - 1/10s - 1/100s - 1/1000s; -1/10000s • Speed: selectable m/s - km/h - Mph - knots
Measurement resolution	20 x 10 ⁻⁶ s (1/50000 s)
Time base	19.2 MHz VCTCXO, stability ±1 ppm from -30 to +85°C (ageing in first year ±1ppm)
Accuracy	±0.0864 s/day for temperatures from -25° to +70°C
POWER SUPPLY	
Power supply	External DC power supply 12–28V; Internal Li-ion batteries
Battery recharging	Built-in smart recharging device
Uptime	> 8 ore
Power ON/OFF	From the keyboard, with dedicated key
USER INTERFACE	
Keyboard	49-key keyboard, covered with a protective waterproof membrane
Display	High-brightness colour TFT graphical display, visual area 152 x 91 mm (7.0"), resolution 800 x 480 Pixel, excellent/good visibility in sunlight, capacitive touch, software brightness adjustment or automatic adjustment with built-in light sensor
Printer	Thermal printer <ul style="list-style-type: none"> • Various font types available • Speed: approx. 8 lines/s • Works with thermal paper
Processing unit	Architecture based on two processors – General CPU and Timing Unit: General CPU (based on SOM, System on Module) <ul style="list-style-type: none"> • Quad Core Arm9 @800MHz Timing Unit (based on FPGA) <ul style="list-style-type: none"> • NIOS II/e 32-bit RISC processor
CONNECTIONS	
Supply	1 x Amphenol socket <ul style="list-style-type: none"> • Connection for external power supply
Timing Inputs	1 x Amphenol socket <ul style="list-style-type: none"> • Start, stop, lap and auxiliary signal inputs 4 x Ø4 mm sockets <ul style="list-style-type: none"> • Start, stop, lap and auxiliary signal inputs
Analogue I/O	1 x Amphenol socket <ul style="list-style-type: none"> • 3 x 0–5V analogue inputs for connecting temperature, humidity and anemometric sensors • 1 x 0–5V digital I/O for connecting/driving external devices
Digital I/O	1 x Amphenol socket <ul style="list-style-type: none"> • 5 x 0–5V digital I/O for connecting/driving external devices
Serial	3 x Amphenol socket <ul style="list-style-type: none"> • RS232/485 serial inputs/outputs for connecting to PC, display boards, REI2 NET, LinkGate, etc. (serial interfaces completely isolated from the timer power supply)
Radio	2 x five-pole sockets <ul style="list-style-type: none"> • Connection to Microgate LinkGate radio transmission system
Linkpod	1 x Amphenol socket <ul style="list-style-type: none"> • Connection to LinkPod system (up to 80 auxiliary inputs completely isolated from the timer power supply)
Host USB	4 x USB A ports <ul style="list-style-type: none"> • USB 2.0 connection to Host devices
Device USB	1 x USB B port <ul style="list-style-type: none"> • USB 2.0 to devices
Ethernet	2 x Ethernet ports <ul style="list-style-type: none"> • 10/100/1000 Mbps Ethernet connection
HDMI	1 x HDMI port <ul style="list-style-type: none"> • Connection to devices with an HDMI input
Audio	1 x 3.5mm stereo jack <ul style="list-style-type: none"> • Amplified audio output for direct connection to headphones/headsets
WiFi+BT	1 x Integrated WIFI/BT + Antenna module <ul style="list-style-type: none"> • WiFi: 802.11 a/b/g/n • Bluetooth: 4.0 + BLE
GNSS	1 x Integrated GNSS + Antenna module <ul style="list-style-type: none"> • Simultaneous reception of GPS/QZSS, GLONASS, BeiDou. • Automatic switching from internal aerial to external active GPS aerial 1 x SMA socket <ul style="list-style-type: none"> • Connection to external active GPS aerial (optional)

5.2 CONNECTORS (PIN OUT)

All connectors are viewed from the contact side (as seen when looking at the REI PRO from the rear). The connection diagrams are provided for documentation purposes. Microgate recommends using its original cables, which are EC approved.

Male connector, Binder 5-pole 240°

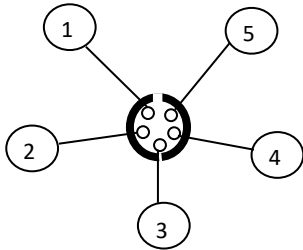

Fig. 1 – Binder 5-pole 240°

Female connector, DIN 41524 5-pole 180°

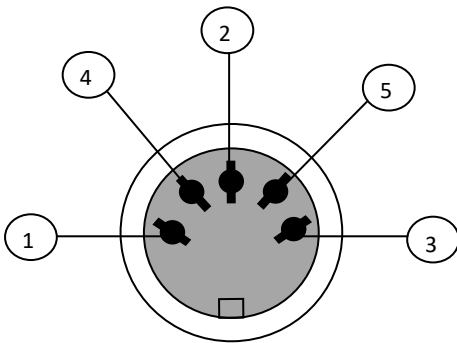

Fig. 2 – DIN 5-pole 180°

Female connector, DIN 45322 6-pole 240°

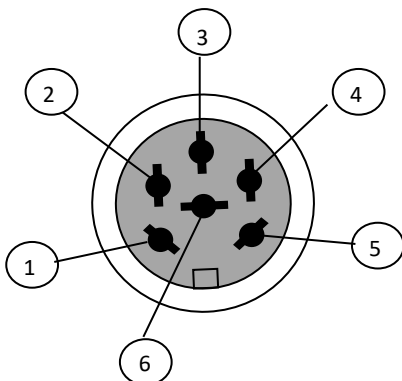

Fig. 17 – DIN 6-pole

5.2.1 Radio 1

Male connector, Binder 5-pole 240°

- 1 RS232 serial input (RXD)

- 2 -5.5 V, max 5 mA
- 3 RS232 serial output (TXD)
- 4 Regulated 5 V output for powering external devices, 200 mA max
- 5 Ground

5.2.2 Radio 2

Male connector, Binder 5-pole 240°

- 1 RS232 serial input (RXD)
- 2 -5.5 V, max 5 mA
- 3 RS232 serial output (TXD)
- 4 Regulated 5 V output for powering external devices, 200 mA max
- 5 Ground

5.2.3 Power Supply

Female connector, DIN 5-pole 180° for power supply

- 1 Ground
- 2 Not connected
- 3 External power supply input (12 V to 28 V permitted)
- 4 Ground
- 5 External power supply input (12 V to 28 V permitted)

5.2.4 Digital I/O

Female connector, DIN 6-pole 240° for connecting digital acquisition devices

- 1 Digital input/output 0 (0/5 V, configurable via software)
- 2 Digital input/output 1 (0/5 V, configurable via software)
- 3 Digital input/output 2 (0/5 V, configurable via software)
- 4 Digital input/output 3 (0/5 V, configurable via software)
- 5 Ground
- 6 Digital input/output 4 (0/5 V, configurable via software)

5.2.5 Analogue I/O

Female connector, DIN 6-pole 240° for connecting analogue acquisition devices

- 1 Analogue input 0 (0..5V)
- 2 Analogue input 1 (0..5V)
- 3 Analogue input 2 (0..5V)
- 4 Regulated 5 V output for powering external devices, 200 mA max
- 5 Ground
- 6 Digital input/output 5 (0/5 V, configurable via software)

5.2.6 Computer A

Female connector, DIN 6-pole 240°, RS232 and RS485 standard signal (with galvanic/digital isolation)

- 1 RS232 serial output (TXD) with galvanic/digital isolation
- 2 Galvanically isolated regulated 5 V output to power external devices, 100 mA max
- 3 RS485+ serial input/output with galvanic/digital isolation
- 4 RS485- serial input/output with galvanic/digital isolation
- 5 Galvanically isolated ground
- 6 RS232 serial input (RXD) with galvanic/digital isolation

5.2.7 Computer B / REI2-NET

Female connector, DIN 6-pole 240°, RS232 and RS485 standard signal (with galvanic/digital isolation)

- 1 RS232 serial output (TXD) with galvanic/digital isolation
- 2 Galvanically isolated regulated 5 V output to power external devices, 100 mA max
- 3 RS485+ serial input/output with galvanic/digital isolation
- 4 RS485- serial input/output with galvanic/digital isolation
- 5 Galvanically isolated ground
- 6 RS232 serial input (RXD) with galvanic/digital isolation

5.2.8 Display Board

Female connector, DIN 6-pole 240°, RS232 and RS485 standard signal (with galvanic/digital isolation)

- 1 RS232 serial output (TXD) with galvanic/digital isolation
- 2 Galvanically isolated regulated 5 V output to power external devices, 100 mA max
- 3 RS485+ serial input/output with galvanic/digital isolation
- 4 RS485- serial input/output with galvanic/digital isolation
- 5 Galvanically isolated ground

- 6 RS232 serial input (RXD) with galvanic/digital isolation

5.2.9 Linkpod

Female connector, DIN 6-pole 240°, RS485 standard signal (with galvanic/digital isolation)

- 1 RS485+ serial output with galvanic/digital isolation
- 2 Galvanically isolated regulated 15 V output, 150 mA max
- 3 Galvanically isolated ground
- 4 RS485- serial output with galvanic/digital isolation
- 5 RS485+ serial input/output with galvanic/digital isolation
- 6 RS485- serial input/output with galvanic/digital isolation

5.2.10 Timing Inputs

Female connector, DIN 6-pole 240°, TTL level signal, non-polarized contacts

- 1 START
- 2 Regulated 5 V output for powering external devices, 200 mA max
- 3 Ground
- 4 LAP
- 5 STOP
- 6 AUX

5.3 SWIMMING LINKPOD CONFIGURATIONS

ReiPro uses the logic channel to identify the type of each detected event and its lane. Depending on the initial configuration selected, the logic channels are automatically associated with the various Pod inputs.

The following table summarizes the logic channels and the associated event types.

Key:

M x: Manual detection for lane x;

P x: Automatic detection (plate) for lane x

B x: Start scales for lane x

MO x: Manual detection opposite side

PO x: Automatic detection opposite side

BO x: Scales opposite side

S x: Start sensor for lane x

F x: Finish sensor for lane x

Config.		1		2		3		4		5	
POD no.	Line no.	Manual		Automatic 1 side		Automatic 2 sides		Automatic 2 sides + scales		3 manual on 2 sides	
		Type	Logic C.	Type	Logic C.	Type	Logic C.	Type	Logic C.	Type	Logic C.
0	1	M 1	11	M 1	11	M 1	11	M 1	11	M 1.1	11
0	2	M 2	12	P 1	31	P 1	31	P 1	31	M 1.2	71
0	3	M 3	13	M 2	12	M 2	12	B 1	51	M 1.3	91
0	4	M 4	14	P 2	32	P 2	32				
0	5	M 5	15	M 3	13	M 3	13	M 2	12	M 2.1	12
0	6	M 6	16	P 3	33	P 3	33	P 2	32	M 2.2	72
0	7	M 7	17	M 4	14	M 4	14	B 2	52	M 2.3	92
0	8	M 8	18	P 4	34	P 4	34				
1	1	M 9	19	M 5	15	M 5	15	M 3	14	M 3.1	13
1	2	M 10	20	P 5	35	P 5	35	P 3	33	M 3.2	73
1	3			M 6	16	M 6	16	B 3	53	M 3.3	93
1	4			P 6	36	P 6	36				
1	5			M 7	17	M 7	17	M 4	14	M 4.1	14
1	6			P 7	37	P 7	37	P 4	34	M 4.2	74

Config.		1		2		3		4		5	
POD no.	Line no.	Manual		Automatic 1 side		Automatic 2 sides		Automatic 2 sides + scales		3 manual on 2 sides	
		Type	Logic C.	Type	Logic C.	Type	Logic C.	Type	Logic C.	Type	Logic C.
1	7			M 8	18	M 8	18	B 4	54	M 4.3	94
1	8			P 8	38	P 8	38				
2	1			M 9	19	M 9	19	M 5	15	M 5.1	15
2	2			P 9	39	P 9	39	P 5	35	M 5.2	75
2	3			M 10	20	M 10	20	B 5	55	M 5.3	95
2	4			P 10	40	P 10	40				
2	5							M 6	16	M 6.1	16
2	6							P 6	36	M 6.2	76
2	7							B 6	56	M 6.3	96
2	8										
3	1					MO 1	111	M 7	17	M 7.1	17
3	2					PO 1	131	P 7	37	M 7.2	77
3	3					MO 2	112	B 7	57	M 7.3	97
3	4					PO 2	132				
3	5					MO 3	113	M 8	18	M 8.1	18
3	6					PO 3	133	P 8	38	M 8.2	78
3	7					MO 4	114	B 8	58	M 8.3	98
3	8					PO 4	134				
4	1					MO 5	115	M 9	18	M 9.1	19
4	2					PO 5	135	P 9	39	M 9.2	79
4	3					MO 6	116	B 9	59	M 9.3	99
4	4					PO 6	136				
4	5					MO 7	117	M 10	20	M 10.1	20
4	6					PO 7	137	P 10	40	M 10.2	80
4	7					MO 8	118	B 10	60	M 10.3	100
4	8					PO 8	138				
5	1					MO 9	119	MO 1	111	MO 1.1	111

Config.		1		2		3		4		5	
POD no.	Line no.	Manual		Automatic 1 side		Automatic 2 sides		Automatic 2 sides + scales		3 manual on 2 sides	
		Type	Logic C.	Type	Logic C.	Type	Logic C.	Type	Logic C.	Type	Logic C.
5	2					PO 9	139	PO 1	131	MO 1.2	171
5	3					MO 10	120	BO 1	151	MO 1.3	191
5	4					PO 10	140				
5	5							MO 2	112	MO 2.1	112
5	6							PO 2	132	MO 2.2	172
5	7							BO 2	152	MO 2.3	192
5	8										
6	1							MO 3	114	MO 3.1	113
...		
9	6							PO 10	140	MO10.1	180
9	7							BO 10	160	MO10.1	200
9	8										

5.3.1 Climbing

Config.		C 1	
POD no.	Line no.	Manual	
		Type	Logic C.
0	1	S 1	
0	2	S 2	
0	3	S 3	
0	4	S 4	
0	5	F 5	1
0	6	F 6	2
0	7	F 7	3
0	8	F 8	4

5.3.2 Rowing

POD no.	Pod Line no.	Line no.	Event
6	1	1	Intermediate 1
6	2	2	Intermediate 1
6	3	3	Intermediate 1
6	4	4	Intermediate 1
6	5	5	Intermediate 1
6	6	6	Intermediate 1
6	7	7	Intermediate 1
6	8	8	Intermediate 1
7	1	9	Intermediate 1
7	2	10	Intermediate 1
7	3		Start from intermediate 1
7	4		Start from intermediate 1
7	5		NOT USED
7	6		NOT USED
7	7		NOT USED
7	8		START from intermediate 1
4	1	1	Intermediate 2
4	2	2	Intermediate 2
4	3	3	Intermediate 2
4	4	4	Intermediate 2
4	5	5	Intermediate 2
4	6	6	Intermediate 2
4	7	7	Intermediate 2
4	8	8	Intermediate 2
5	1	9	Intermediate 2
5	2	10	Intermediate 2
5	3		START from intermediate 2
5	4		START from intermediate 2
5	5		NOT USED
5	6		NOT USED

5	7		NOT USED
5	8		START from intermediate 2
2	1	1	Intermediate 3
2	2	2	Intermediate 3
2	3	3	Intermediate 3
2	4	4	Intermediate 3
2	5	5	Intermediate 3
2	6	6	Intermediate 3
2	7	7	Intermediate 3
2	8	8	Intermediate 3
3	1	9	Intermediate 3
3	2	10	Intermediate 3
3	3		START from intermediate 3
3	4		START from intermediate 3
3	5		NOT USED
3	6		NOT USED
3	7		NOT USED
3	8		START from intermediate 3
0	1	1	STOP
0	2	2	STOP
0	3	3	STOP
0	4	4	STOP
0	5	5	STOP
0	6	6	STOP
0	7	7	STOP
0	8	8	STOP
1	1	9	STOP
1	2	10	STOP
1	3		START
1	4		START
1	5		NOT USED
1	6		NOT USED

1	7		NOT USED
1	8		START
8	1		START
8
8	8		START
9	1		START
9
9	8		START

5.3.2.1 POD Connection

It is important consider the connections between the various PODs. In fact, if there is a long distance between the timer and the last POD (over 1000 metres), it is advisable to use a Linkpod Repeater.

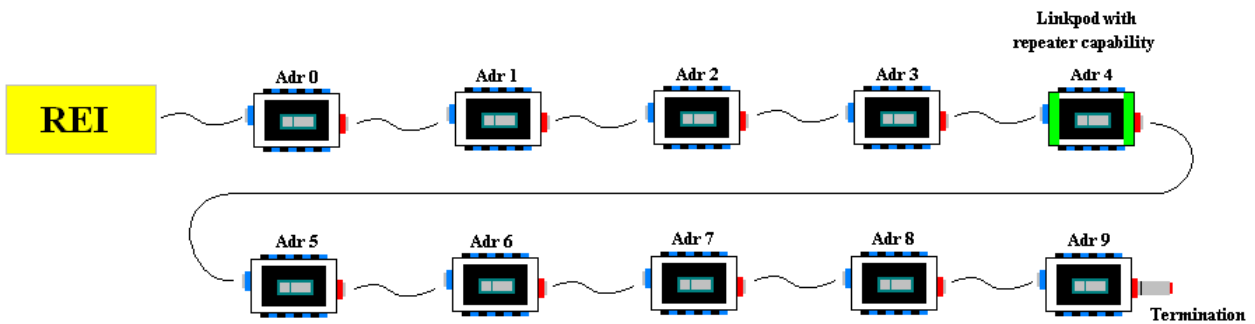

5.4 PROTOCOLS

The transmission protocols used by the Rei Pro are perfectly compatible with those of the REI2. Therefore, please refer to the user manuals

- REI2 - Single Starts Program - Document Revision: 1095_001 – Chapter 26
- REI2 - Transmission protocols - Document Revision: 1095_002

which you can download from <http://www.microgate.it/Timing/Supporto/Manuali/REI2>

5.5 REI PRO UPDATER

It is very simple to update the firmware in your Rei Pro. Just follow this easy procedure:

1. Download the Pro Updater program from <http://www.reipro.it/it/download>
2. Run Rei Pro Updater;
3. Take the Rei Pro and press the F1 key to switch it on;
4. Connect the Rei Pro to the PC with the USB cable;
5. Follow the instructions;
6. Restart the Rei Pro normally;
7. You are now ready to use your Rei Pro.

As for all update procedures, make sure that the batteries in the PC and the Rei Pro are fully charged or that they are connected to a power supply, and that the PC has a stable internet connection.